

Details

Eternit Wellplatte



Inhaltsverzeichnis

FIRST	
First mit Alu - Well-Lüfter.....	4
First mit Entlüftungsfirststein	5
First mit Firstkappe.....	6
First mit Gelenkfirstkappe	7
First mit Gratstein	8
Pultfirst mit Shedfirstkappe 75°.....	9
TRAUFE	
Traufe mit Welle P6 Startleiste.....	10
Traufe mit Universal-Traufenstein.....	11
Traufe mit Unterleger	12
Traufe mit Kastenrinne	13
Traufe mit Universal-Traufenstein.....	14
GRAT	
Grat mit Alu - First- und Gratrolle.....	15
Grat abgehoben mit Bleiblech	16
Grat abgehoben mit Firstdichtungsband.....	17
Grat mit Firstdichtungsband.....	18
KEHLE	
Kehle in Blechausführung	19
Grabrinne	20
ORTGANG	
Ortgang mit Blech	21
Ortgang mit Giebelabschlussstein	22
Ortgang mit Überstand	23
Ortgang mit Verblechung.....	24

Details Wellplatte

WANDANSCHLUSS	
Wandanschluss - Giebelseitig.....	25
Wandanschluss - Firstseitig.....	26
DACHKNICK	
Dachknick.....	27
Dachknick.....	28
SONSTIGES	
Ausstiegfenster	29
Befestigungsarten.....	30
Profilquerschnitt Welle P6.....	31
Befestigung	32
Schnürschema Links- und Rechtsdeckung.....	33
Schnürschema Linksdeckung	34
Scheinkamin.....	35
Schneeschutz.....	36
FORMTEILE	
Universal - Traufenstein	37
Unterleger.....	38
Zargestreifen.....	39
Firstkappe.....	40
Firststreifen	41
Gelenkfirstkappe.....	42
Gelenkfirstkappe.....	43
Shedfirstkappe.....	44
Universal - Übergangsstein	45
Entlüftungsfirststein.....	46
Gratstein und Gratsteinansetzer.....	47
Giebelabschlussstein - rechts.....	48
Giebelabschlussstein - links.....	49

Download: ZIP-Archiv gesamt Details

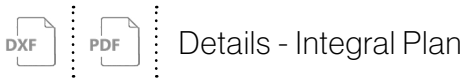

Info:

Beim Klick auf das Symbol wird das entsprechende Detail geladen und kann gespeichert werden.

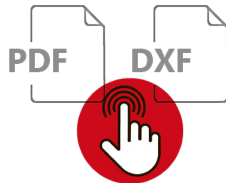



First mit Alu - Well-Lüfter P6/400 (Lüftungsquerschnitt 120 cm²/Stk. je Dachseite)

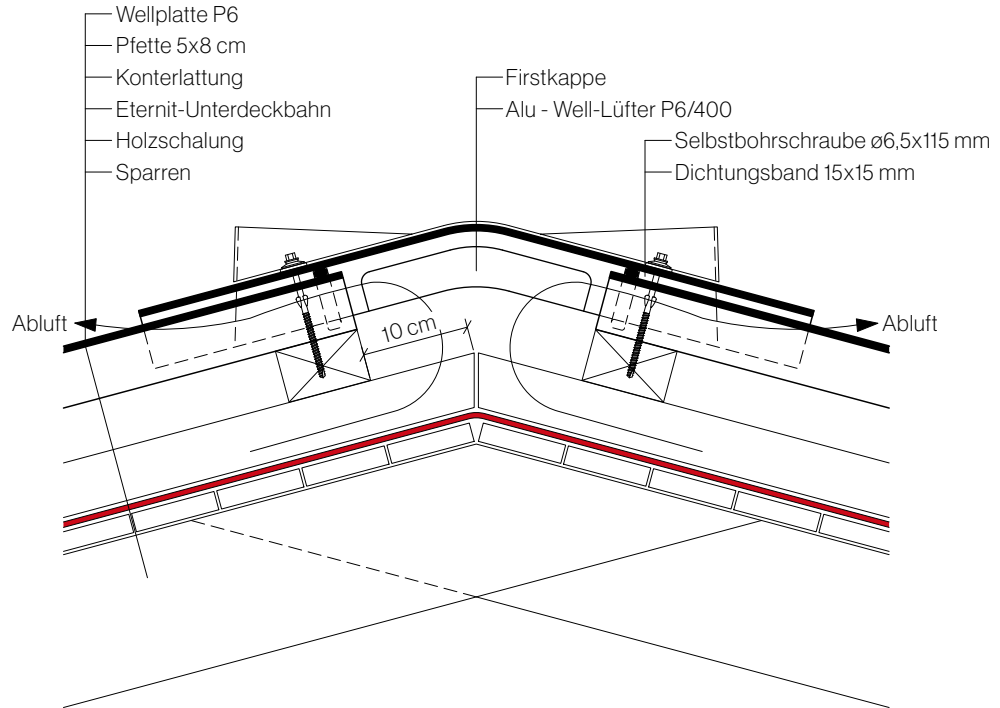

First mit Entlüftungs-Firststein und Universal-Übergangsstein (Entlüftungsquerschnitt 400 cm²/lfm First und Dachseite)

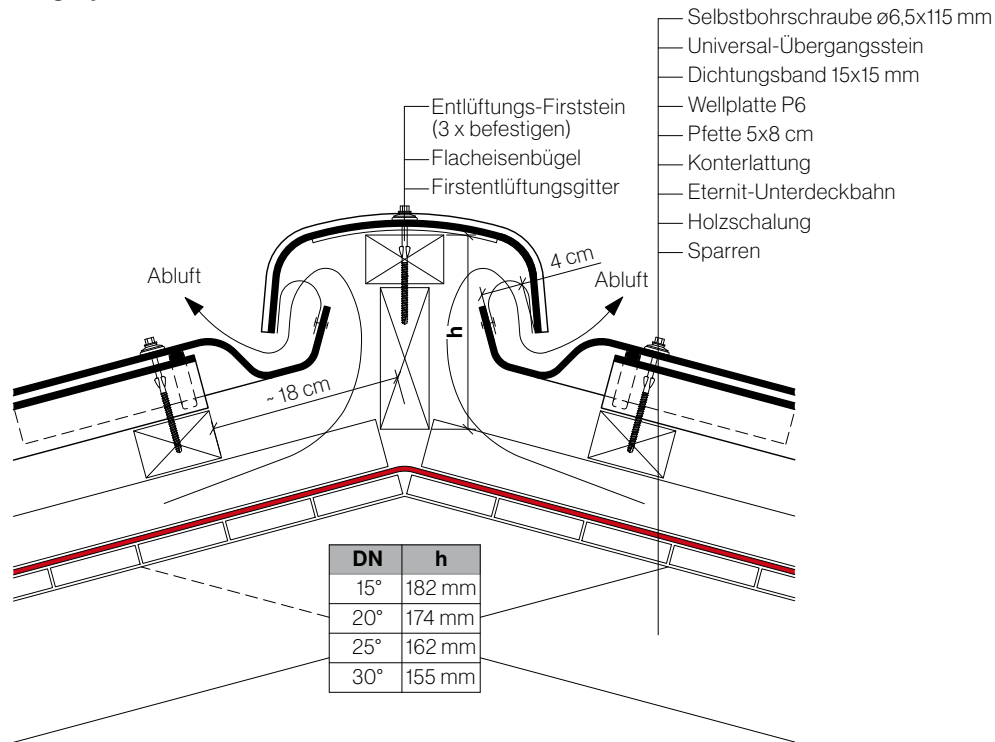



First mit Firstkappe (Entlüftungsquerschnitt 250 cm²/lfm First und Dachseite)

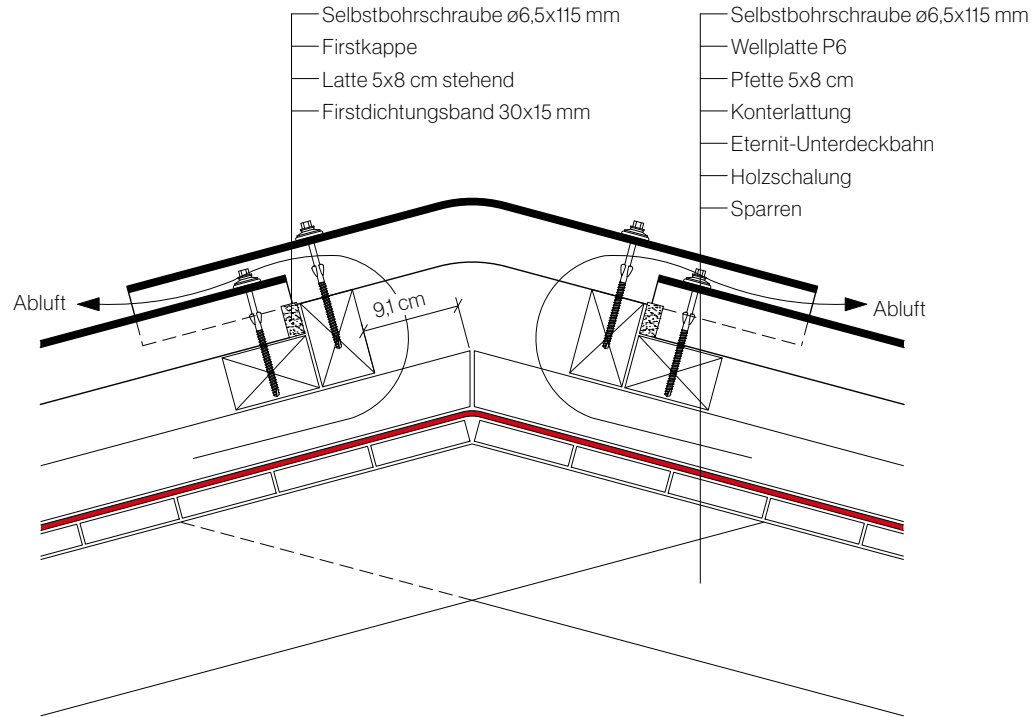

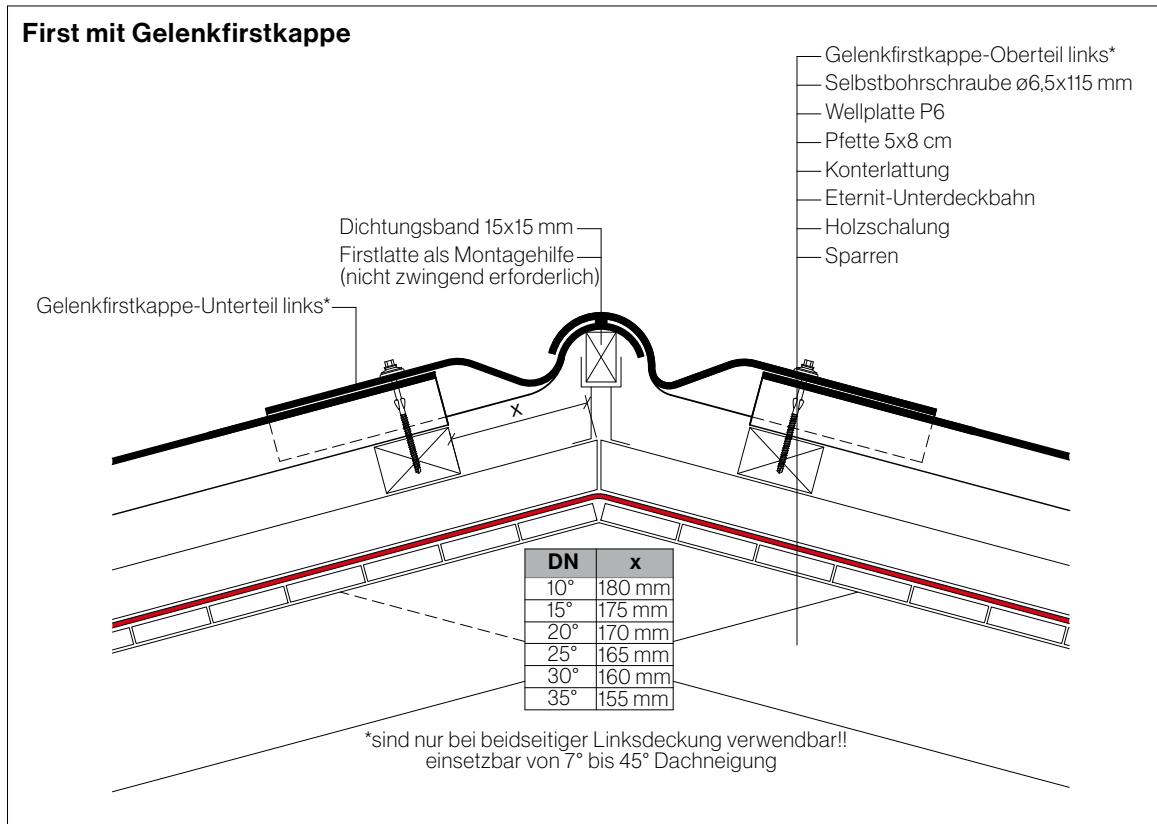



First mit Gratstein und Universal-Übergangsstein (Entlüftungsquerschnitt 300 cm²/Stk. First und Dachseite)

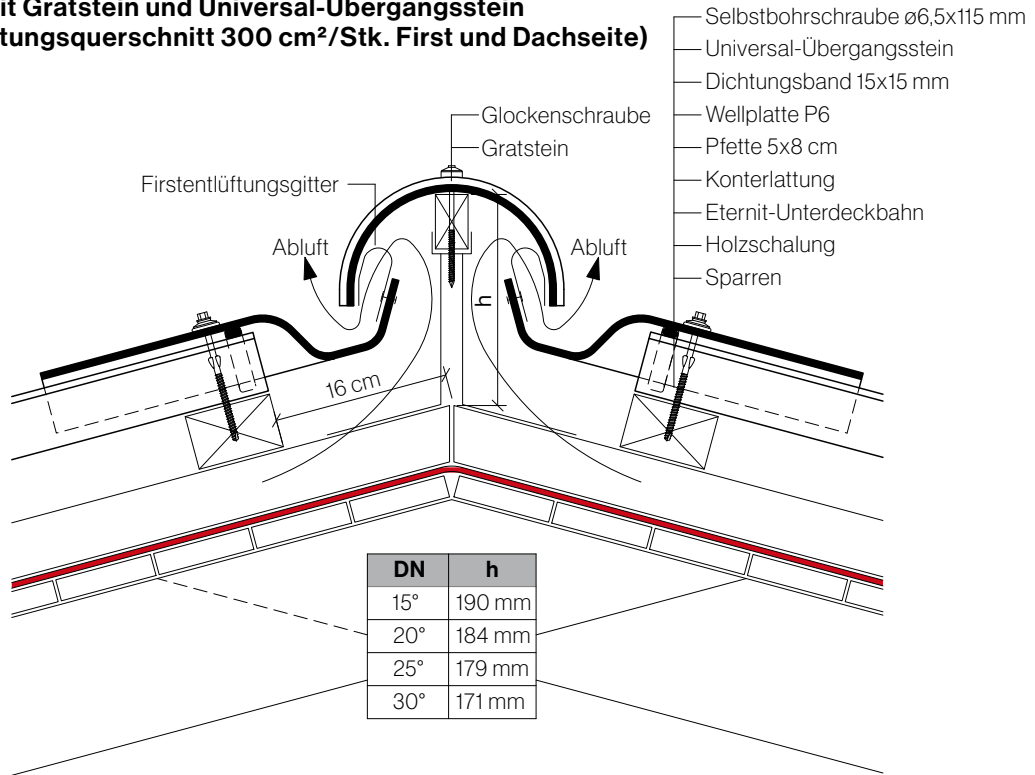

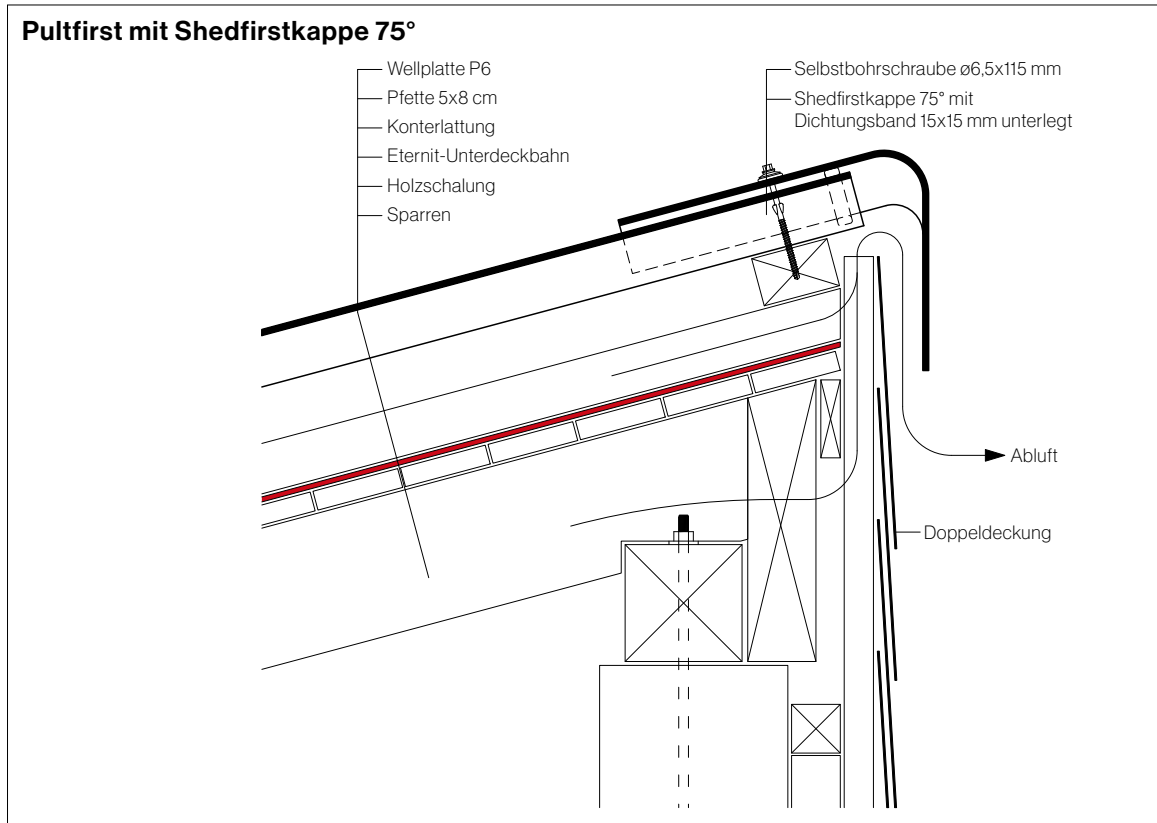



Traufe mit Welle P6 Startleiste mit Einlaufblech oder Tropfnase

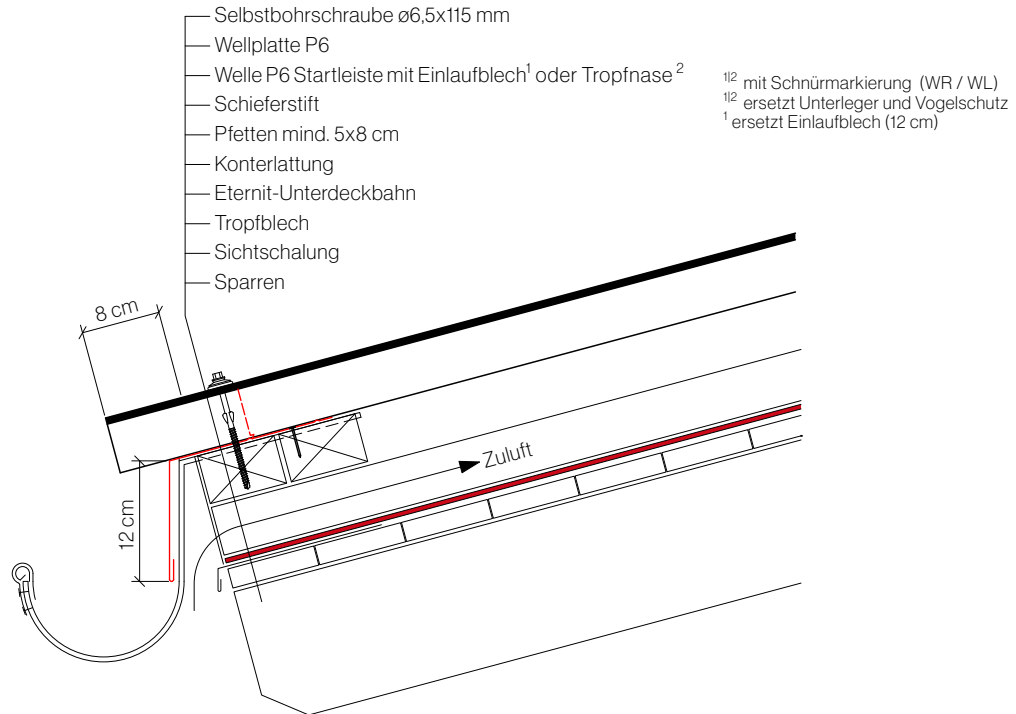

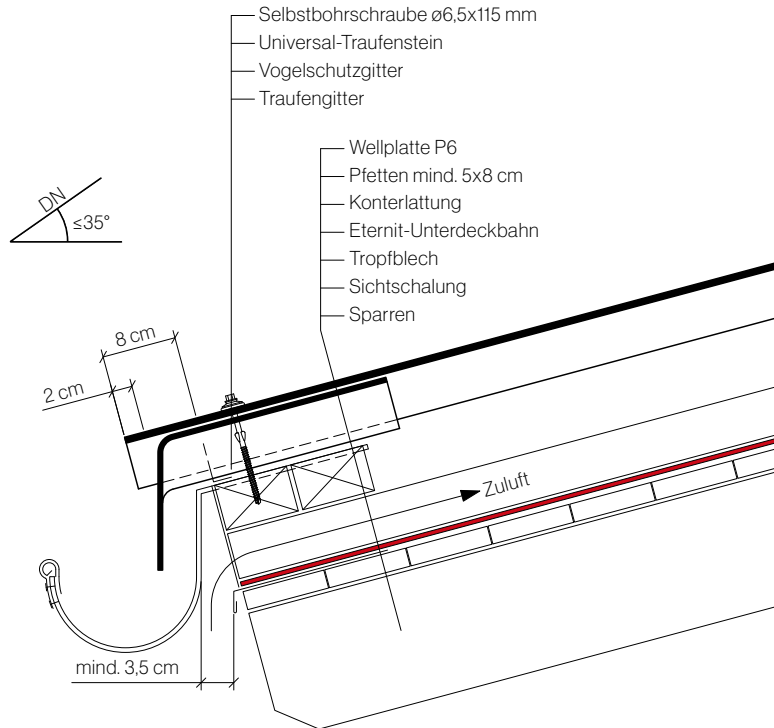
**Traufe mit Universal-Traufenstein 80x250 mm;
unterlegt mit Vogelschutzgitter**



Traufe mit Unterleger 250 mm; unterlegt mit Vogelschutzgitter

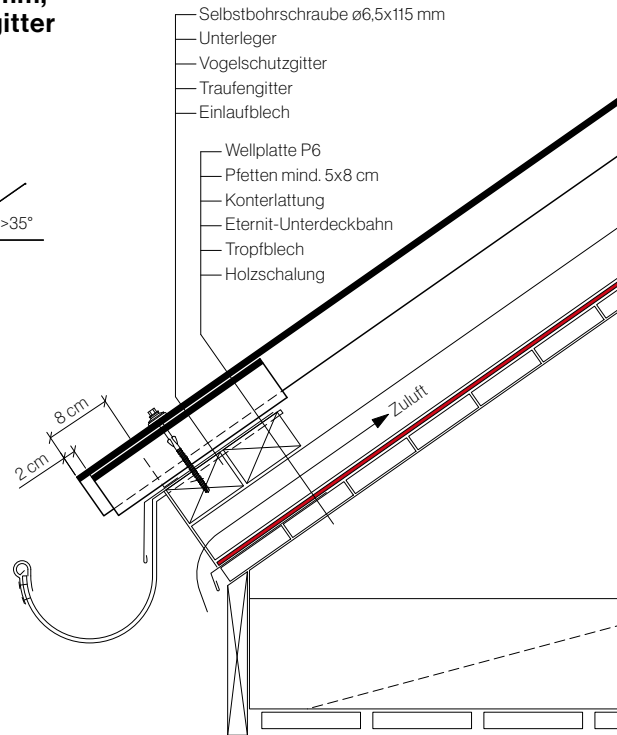
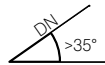

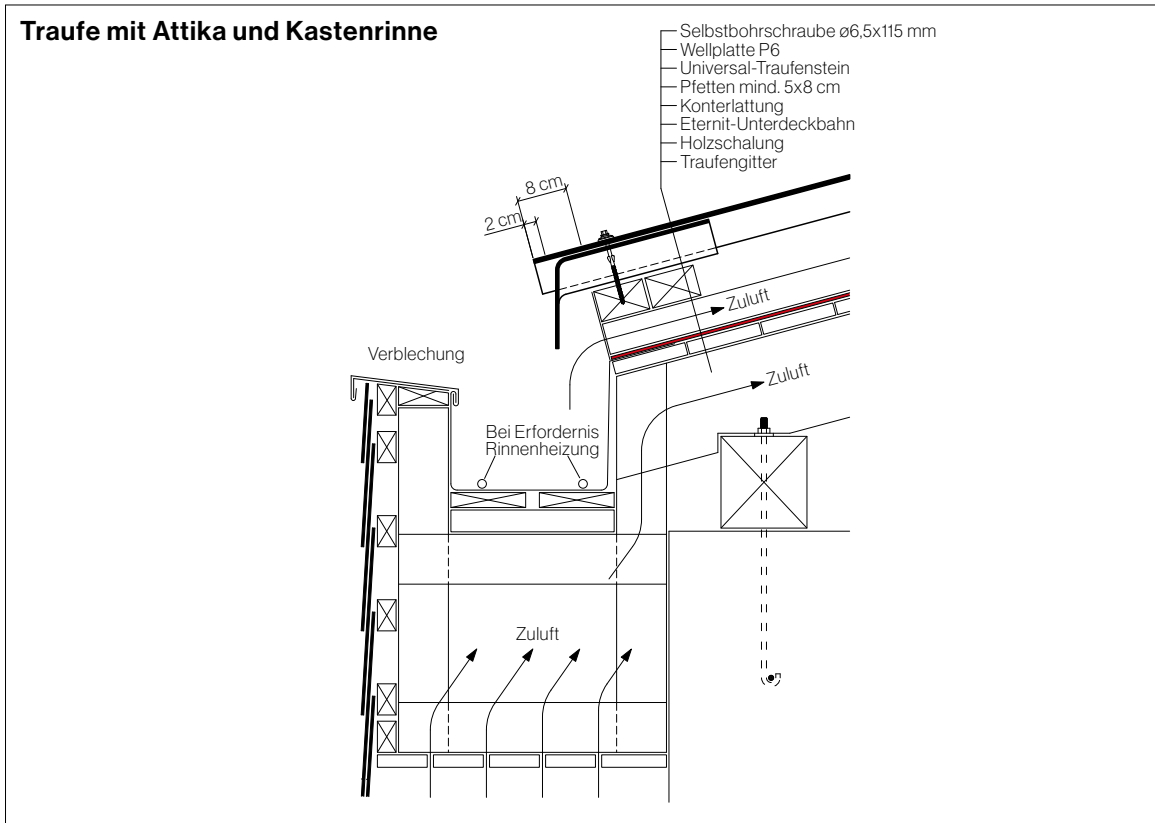



**Traufe mit Universal-Traufenstein 80x250 mm;
unterlegt mit Vogelschutzgitter**

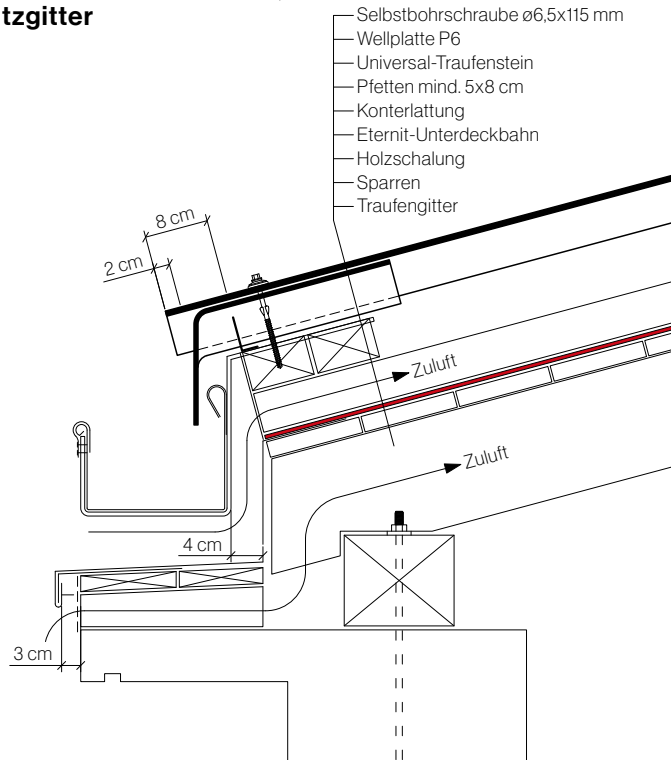

Grat mit Alu - First- und Gratrolle (Breite: 390 mm)
(Entlüftungsquerschnitt 95 cm²/lfm First und Dachseite)

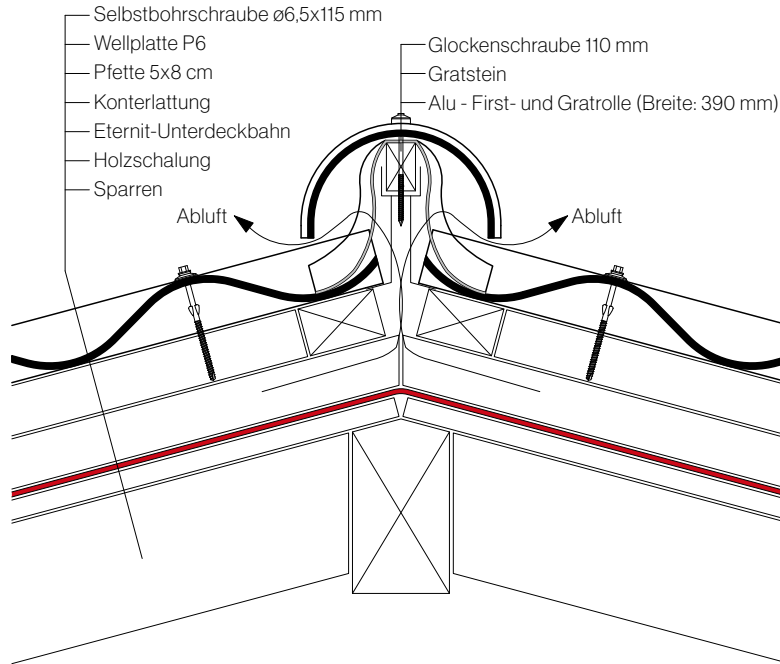



Grat abgehoben mit Bleiblech als Abdichtung

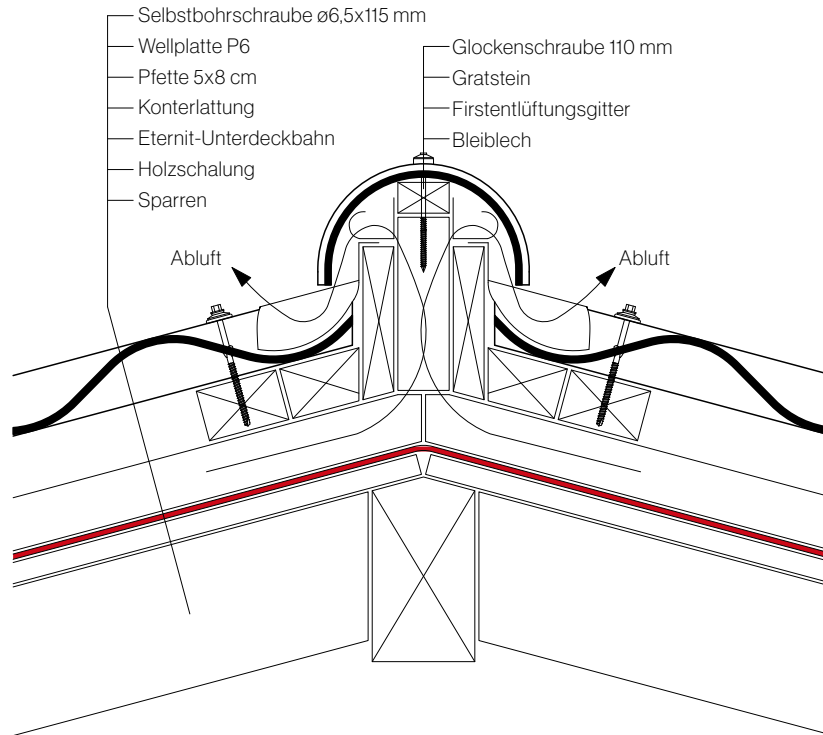

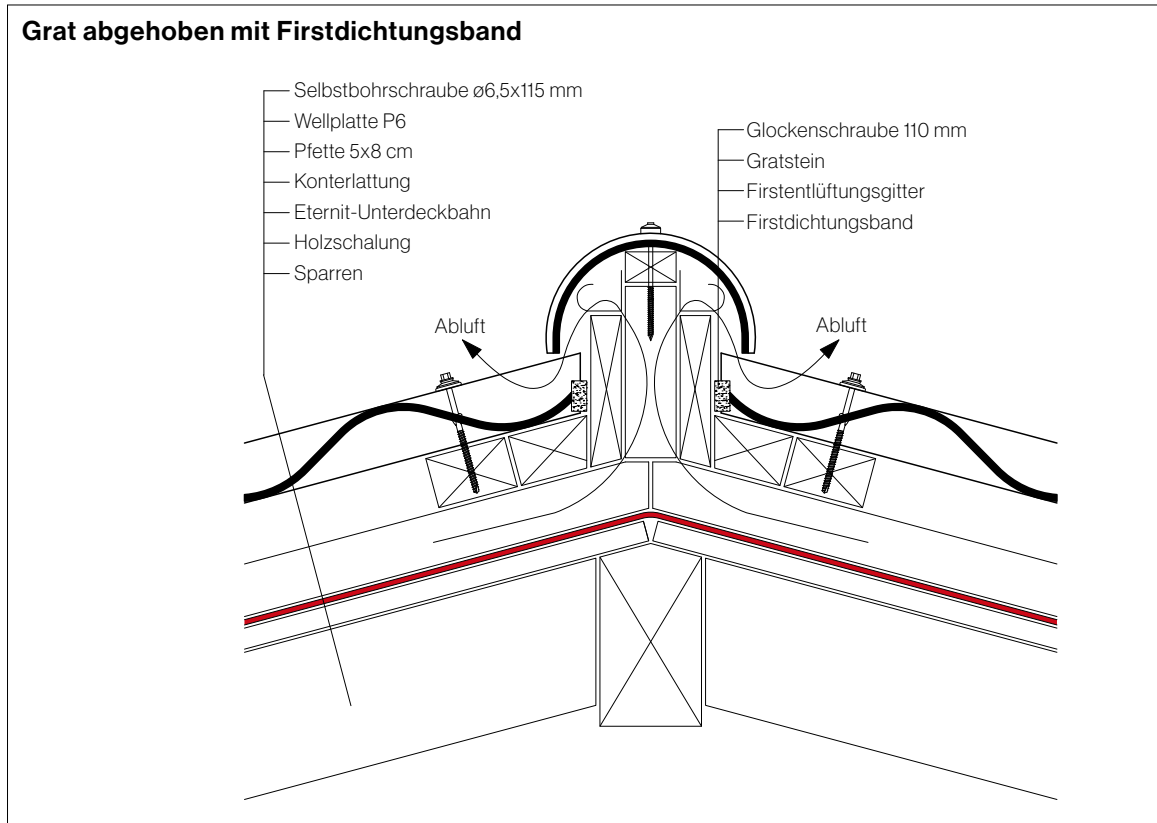



Grat mit Firstdichtungsband

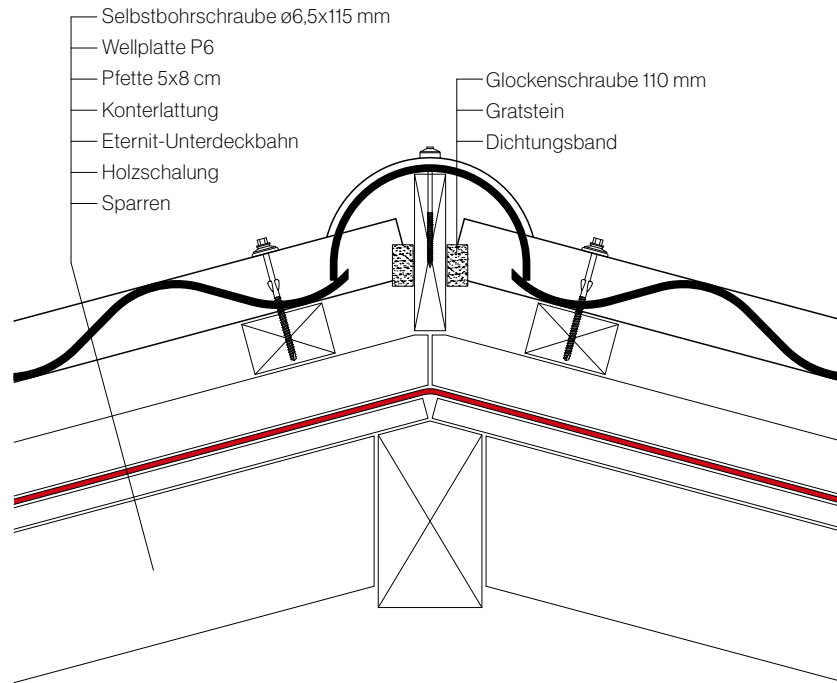

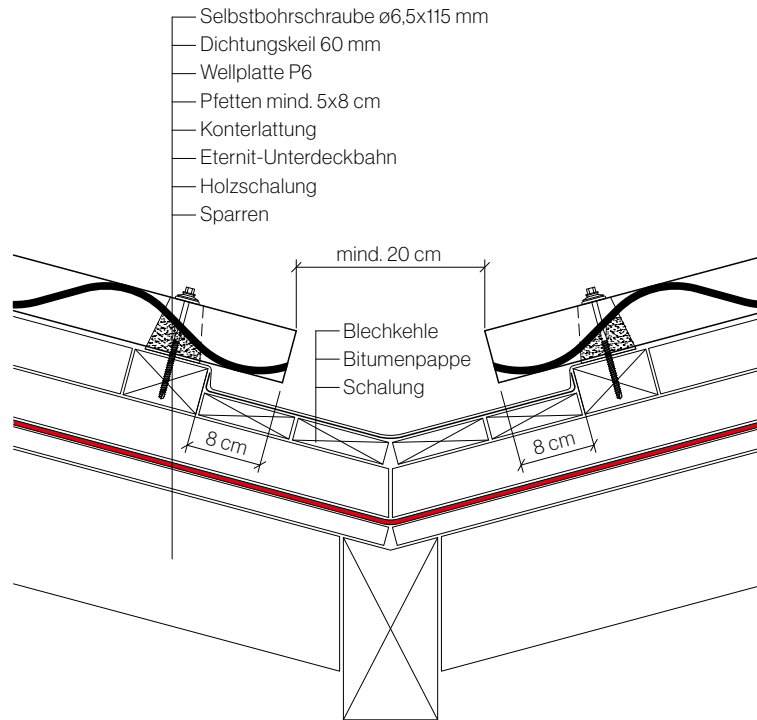
Kehle in Blechausführung



Grabenrinne

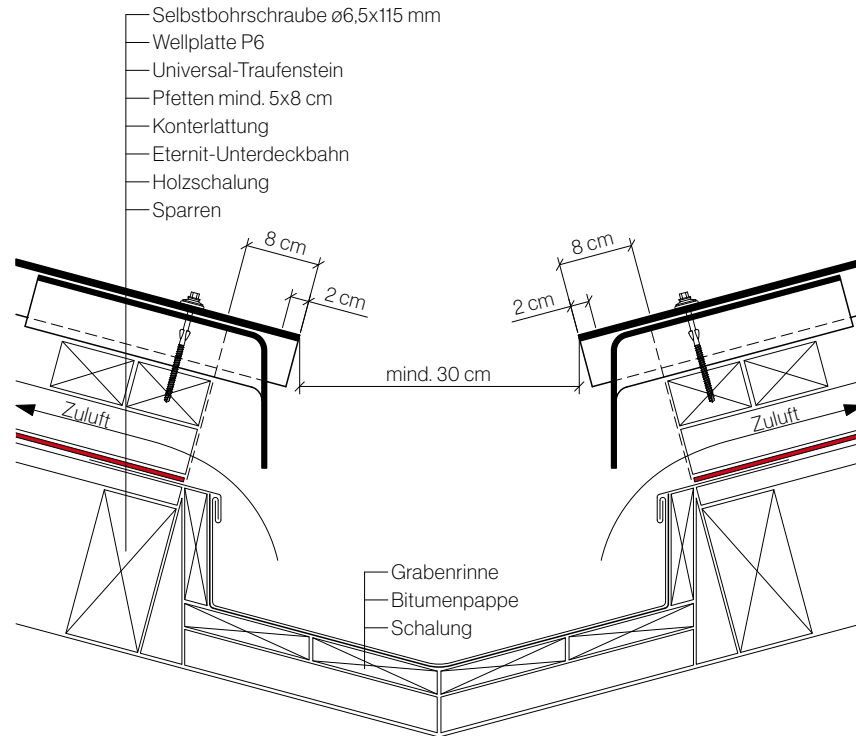

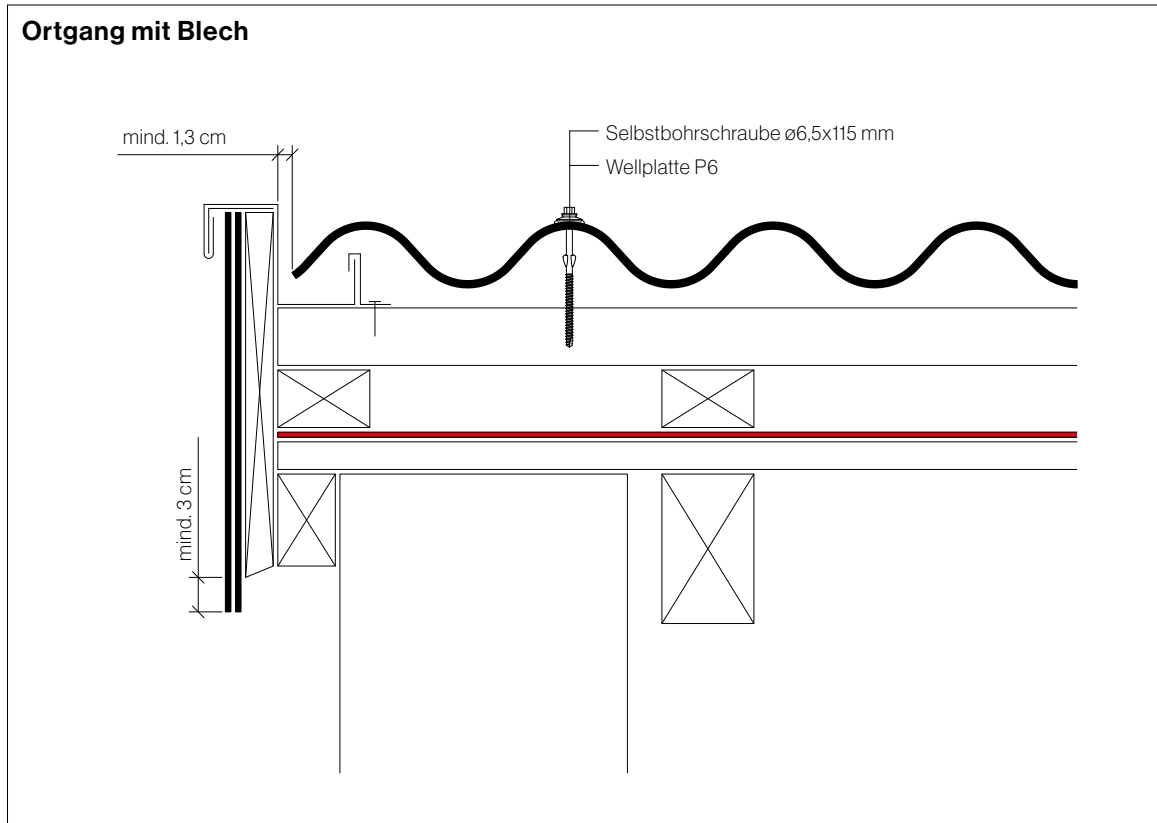



Ortgang mit Giebelabschlussstein

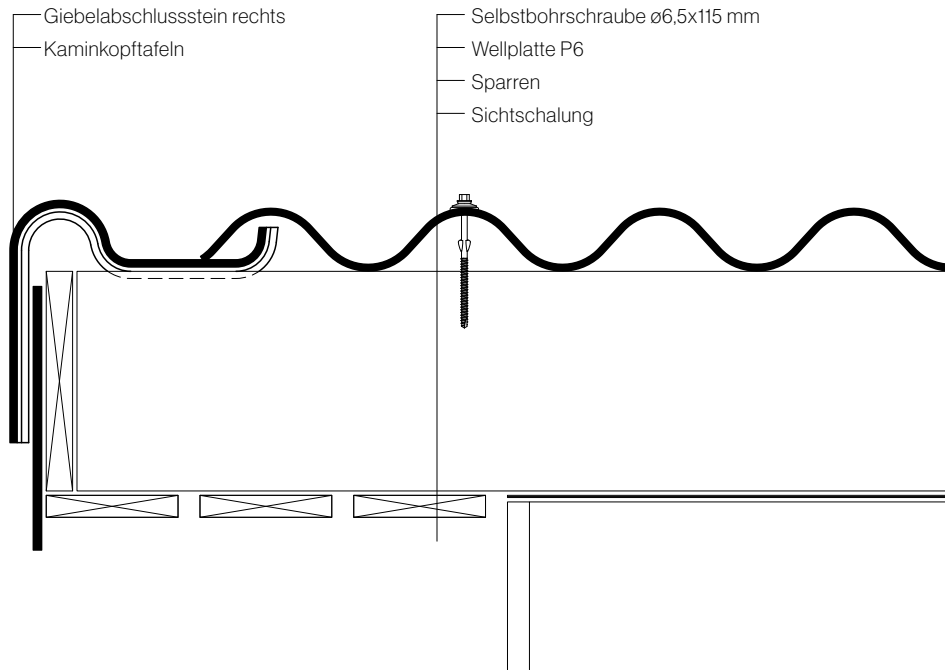

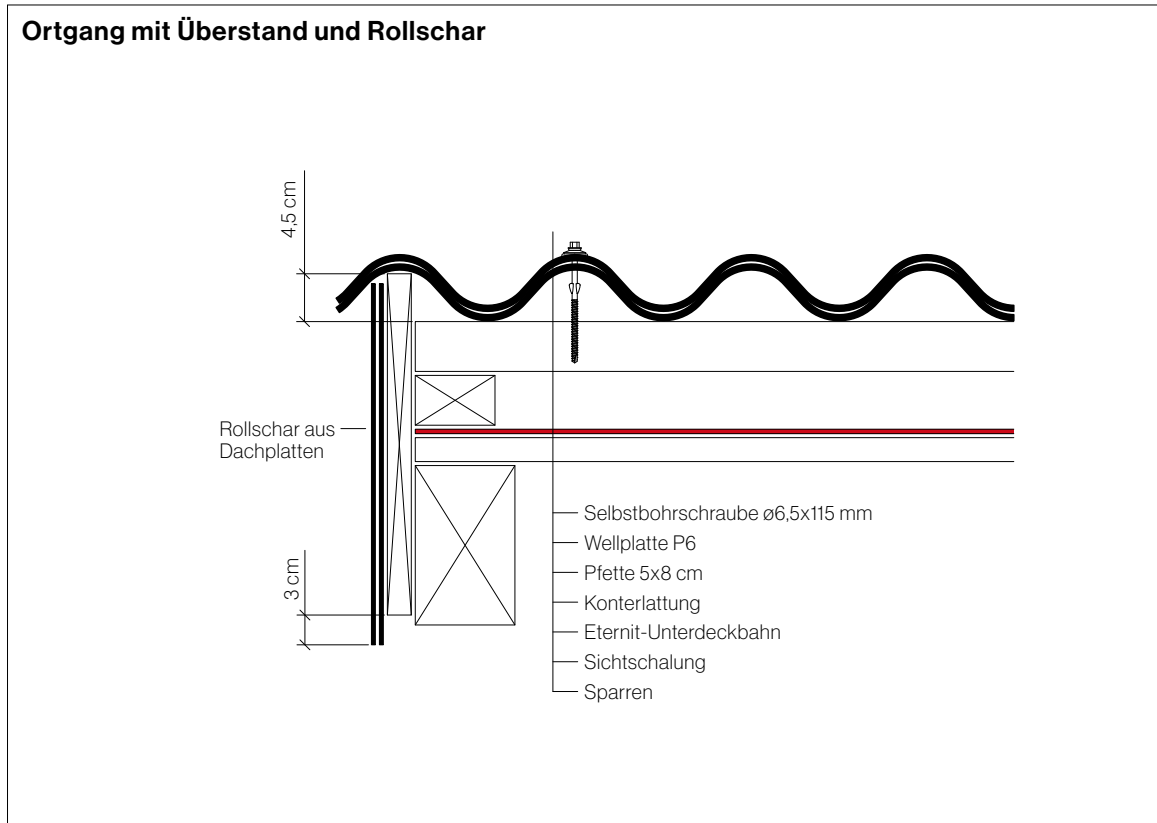



Ortgang mit Verblechung und Holzverkleidung

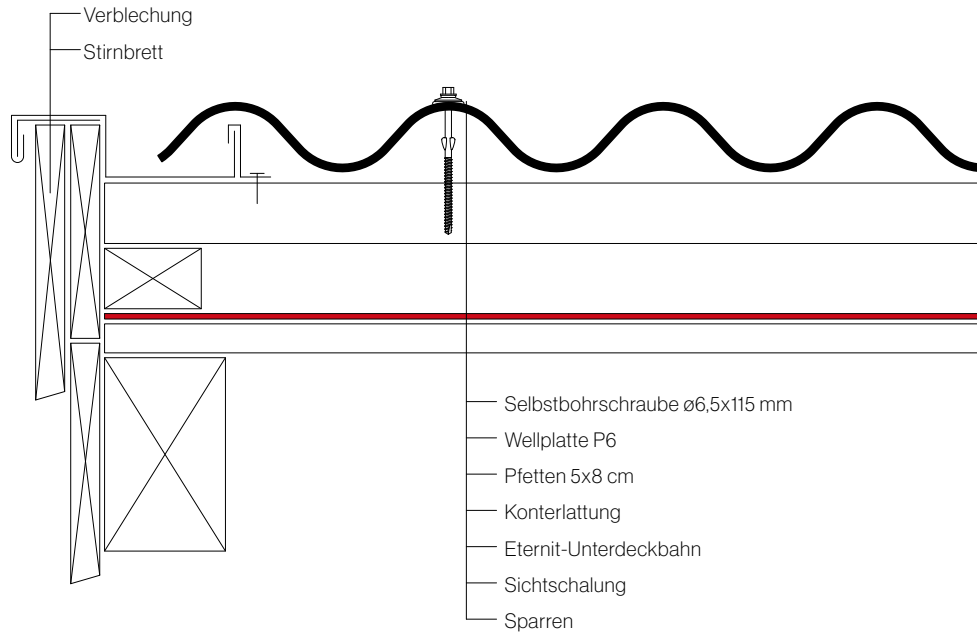

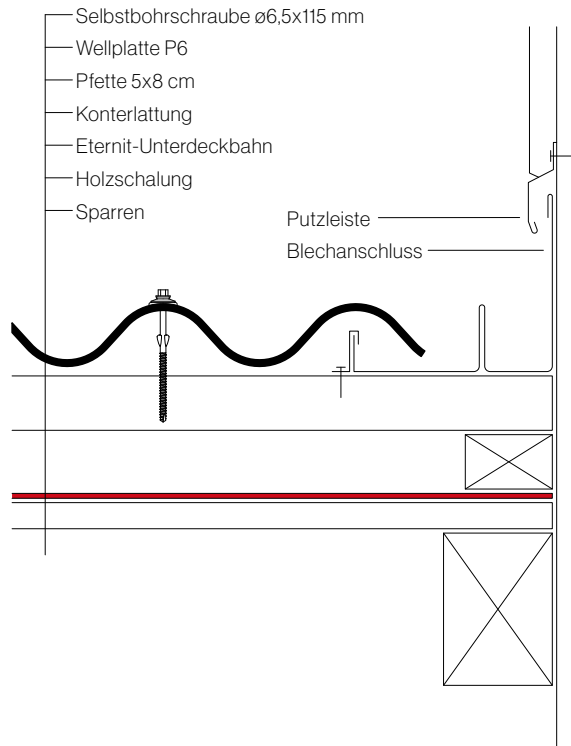
Wandanschluss - Giebelseitig



Wandanschluss - Firstseitig

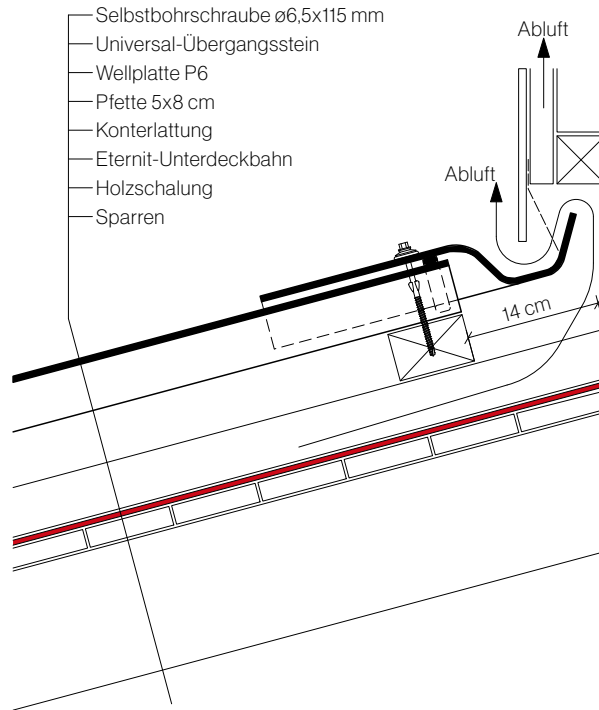

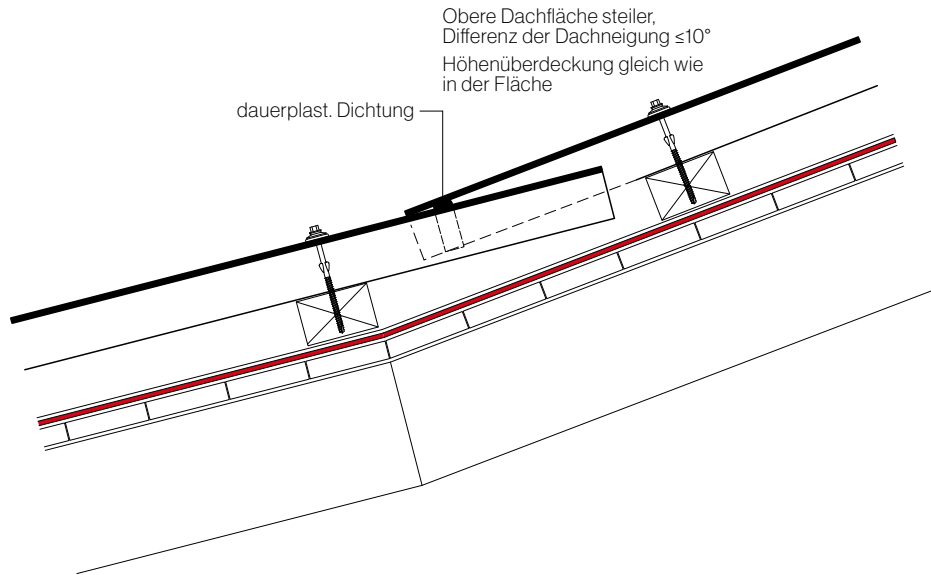
**Dachknick (Obere Dachfläche steiler,
Differenz der Dachneigung $\leq 10^\circ$)**



Dachknick (Obere Dachfläche steiler, Differenz der Dachneigung zwischen 10° und 25°)

Obere Dachfläche steiler, Differenz
der Dachneigungen zwischen 10° und 25°
Höhenüberdeckung gleich wie
in der Fläche

Lösung:

Unterleger
Universelles Anschlussband
("Uni-Flex Alu")

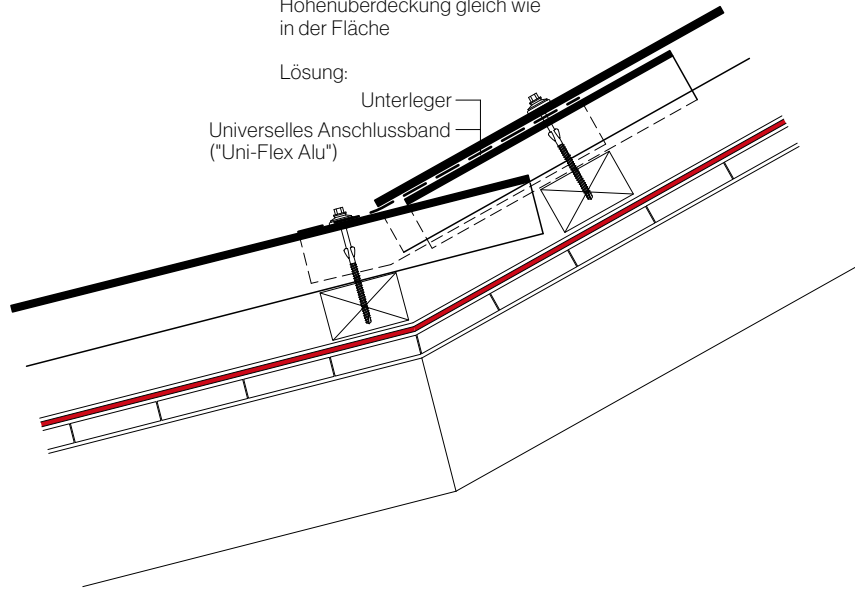

Ausstiegswenster

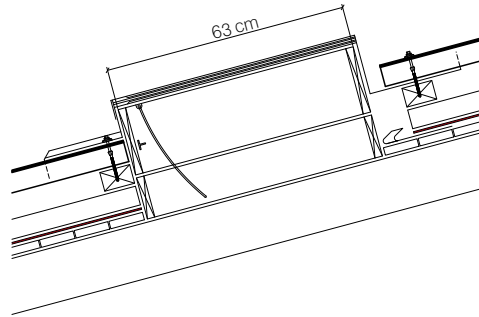

Ausgangsöffnung: 530 x 480 mm

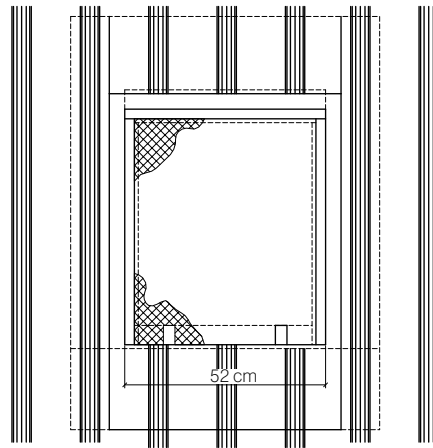



Befestigungsarten

Holzpette

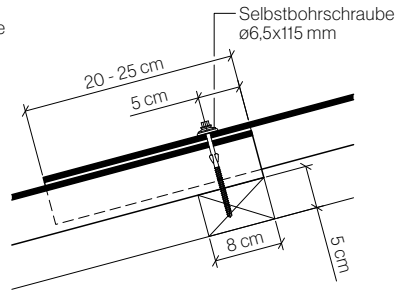

Stahlpette
(Mindestgurtstärke: 3 mm)

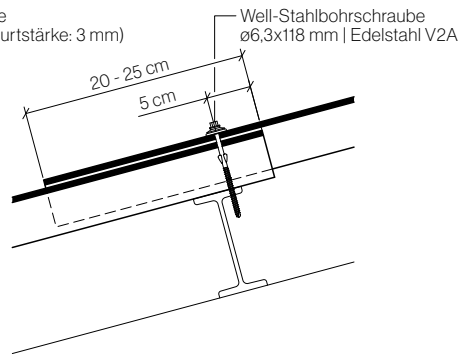

Koppelpette

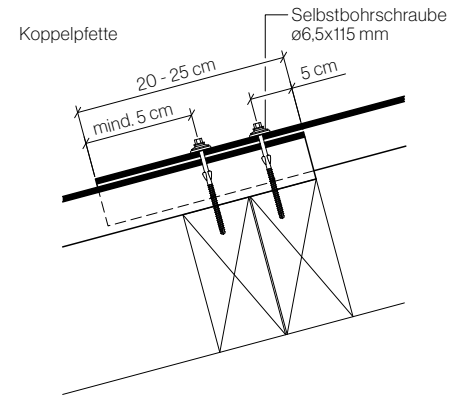

Profilquerschnitt - Welle P6 (Befestigung mit Selbstbohrschrauben $\varnothing 6,5 \times 115$ mm am 2. und 5. Wellenberg)

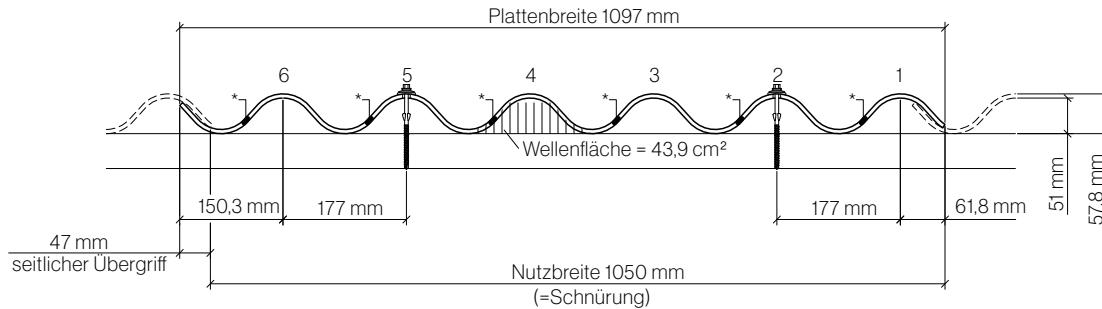
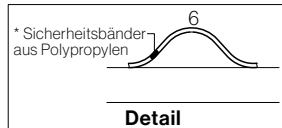



Sachgerechte Befestigung der Wellplatte mit Selbstbohrschraube

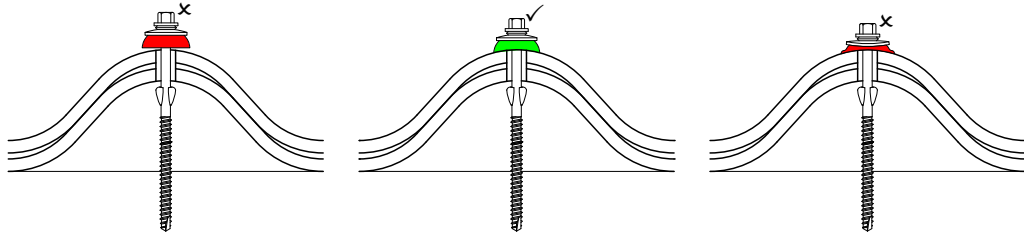

Bei der Befestigung der Wellplatten ist besonders auf die Dichtung zu achten. Diese muss dicht an der Wellplatte anliegen, soll aber auch noch etwas Spiel haben. Wird die Dichtung zu stark gequetscht, kann dies zu Undichtigkeiten oder zu Schäden an der Dichtung oder der Wellplatte führen.

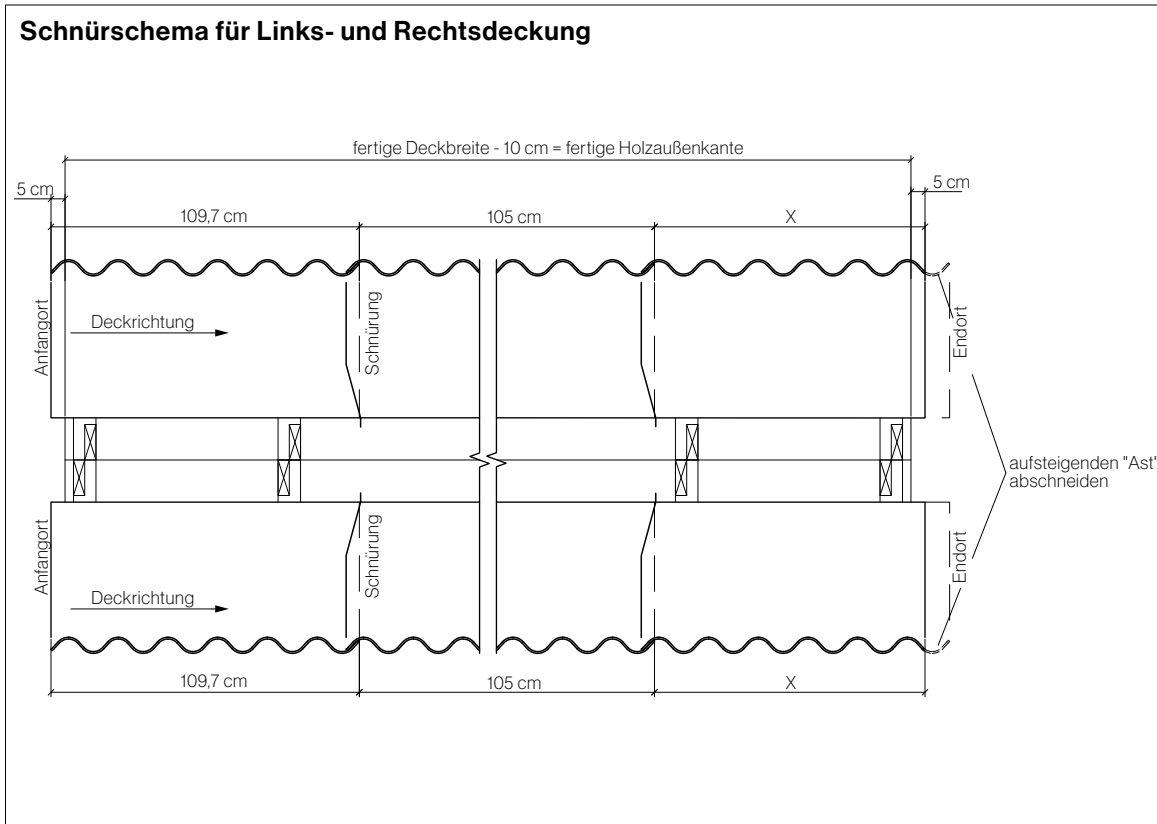

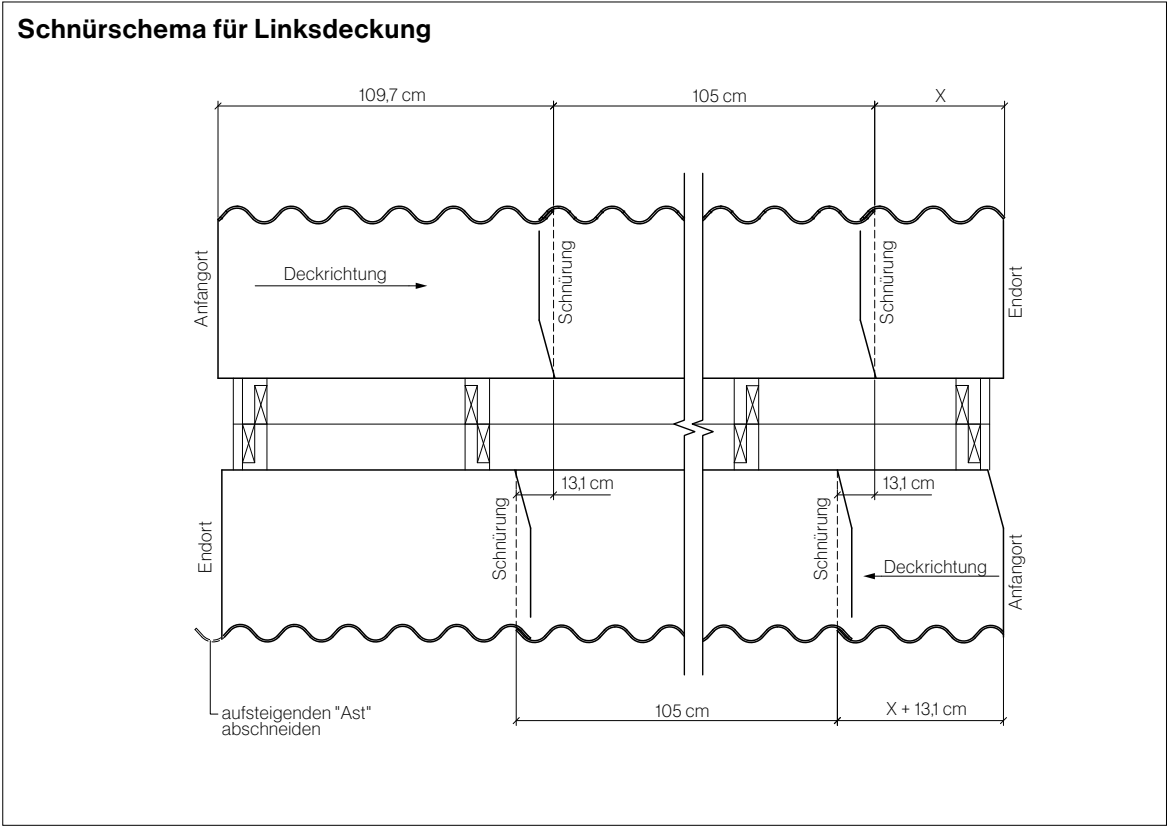

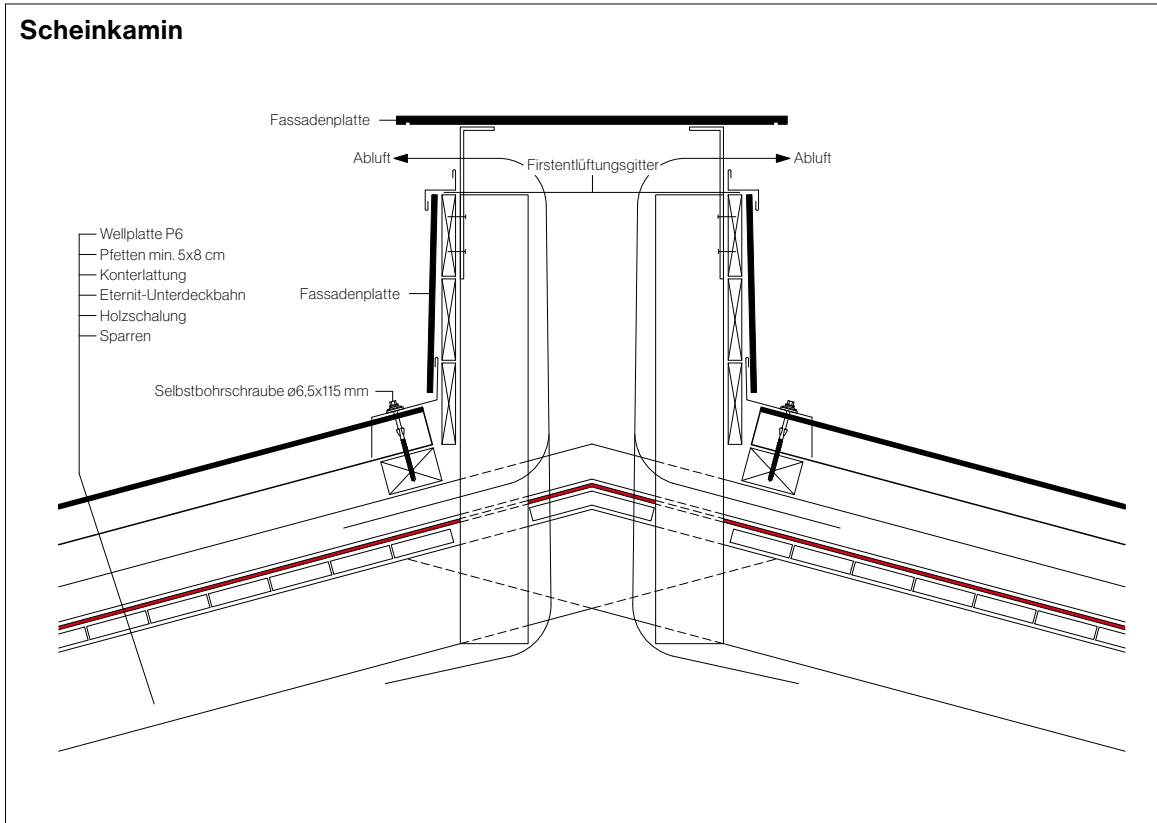



Schneeschutz mit Schneefangprofil

30 mm

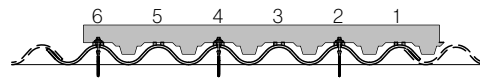
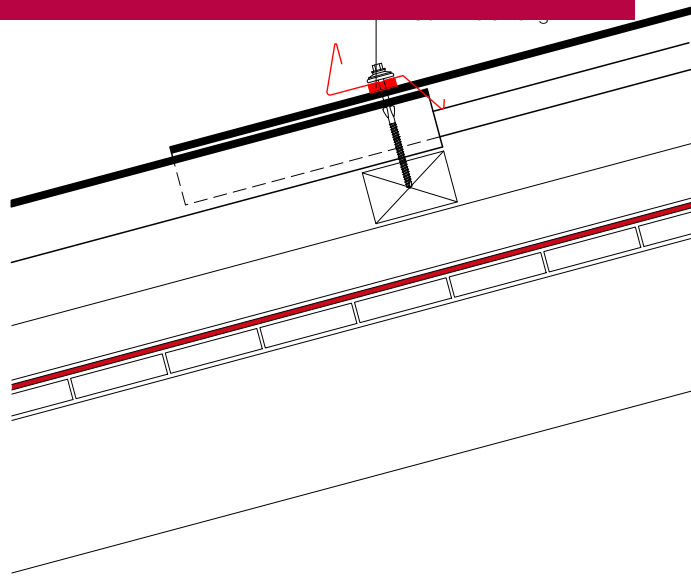

Linksdeckung (mind. dreifache Befestigung)

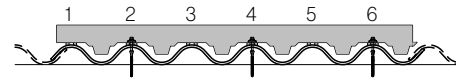

Rechtsdeckung (mind. dreifache Befestigung)

Universal - Traufenstein
(Format: 80x250x1084x6 mm)

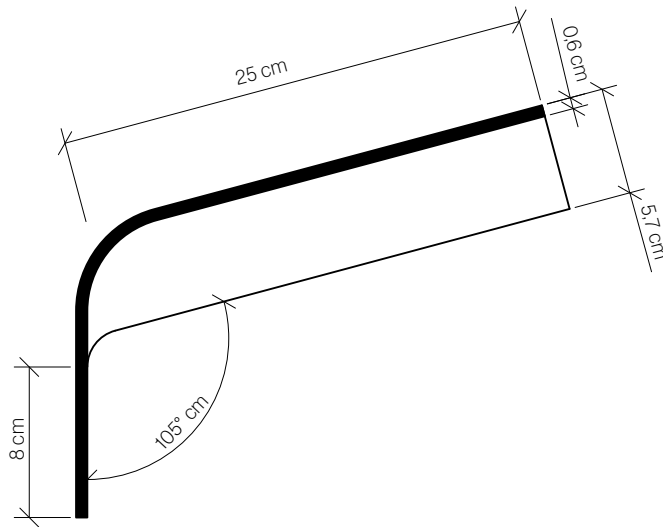

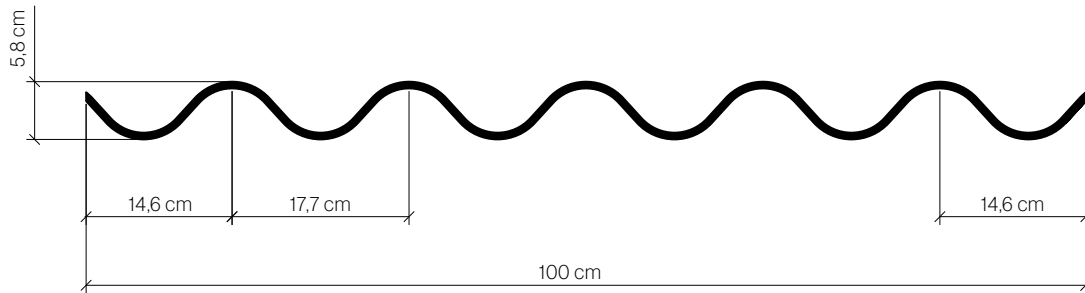
**Unterleger****(Format: 250x1000x6,8 mm)**

Zargenstreifen
(Format: 200x1097x6 mm)

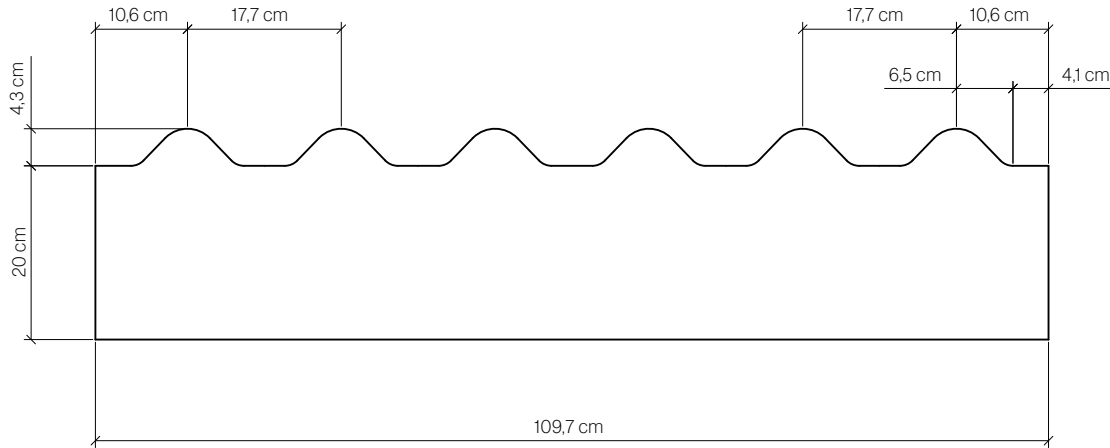



Firstkappe

(Format: 1097x300x6 mm)

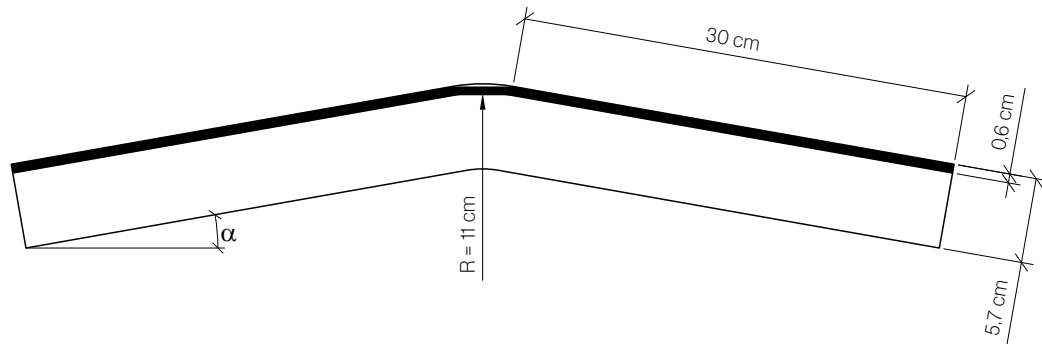

Firstkappe für Dachneigungen (α) von:

10°	13°	15°	18°	21°	24°	27°	30°	34°	38°	42°	46°
-----	-----	-----	-----	-----	-----	-----	-----	-----	-----	-----	-----

Firststreifen
(Format: 200x988x6,3 mm)

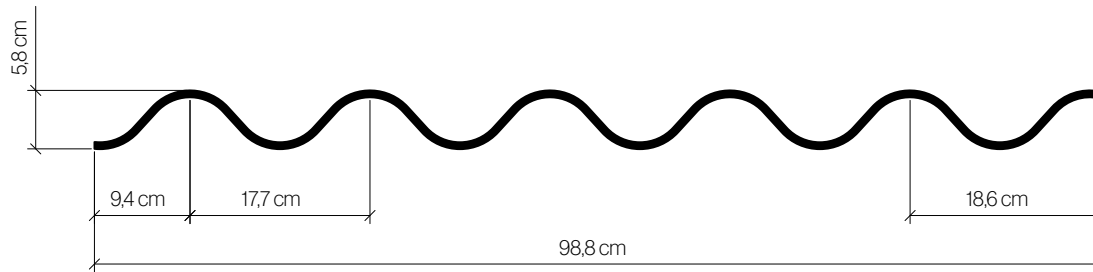



Gelenkfirstkappe-Oberteil links
(Format: 350x1097x6 mm)

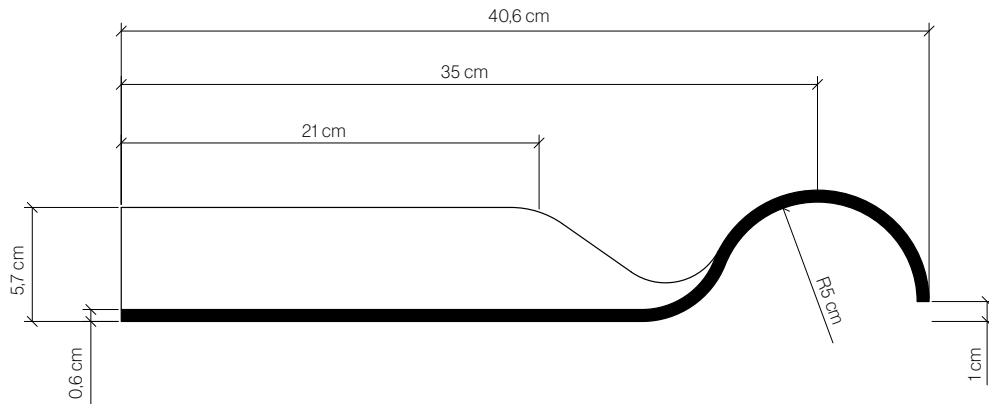

Gelenkfirstkappe-Unterteil links
(Format: 350x1097x6 mm)

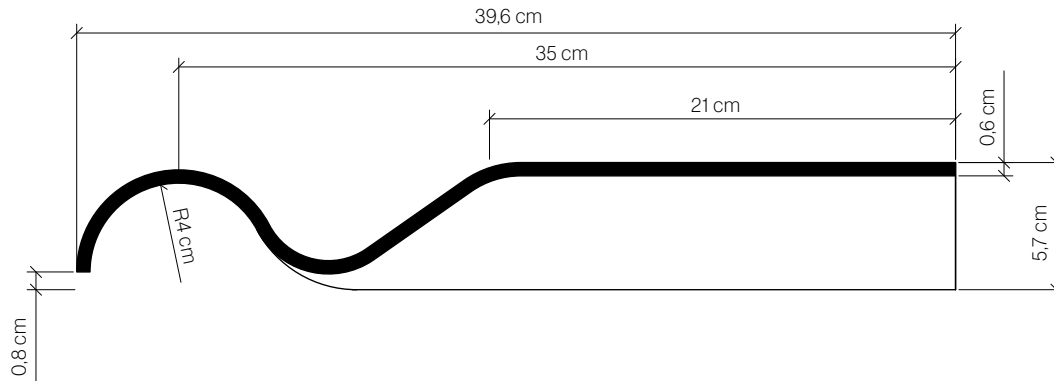

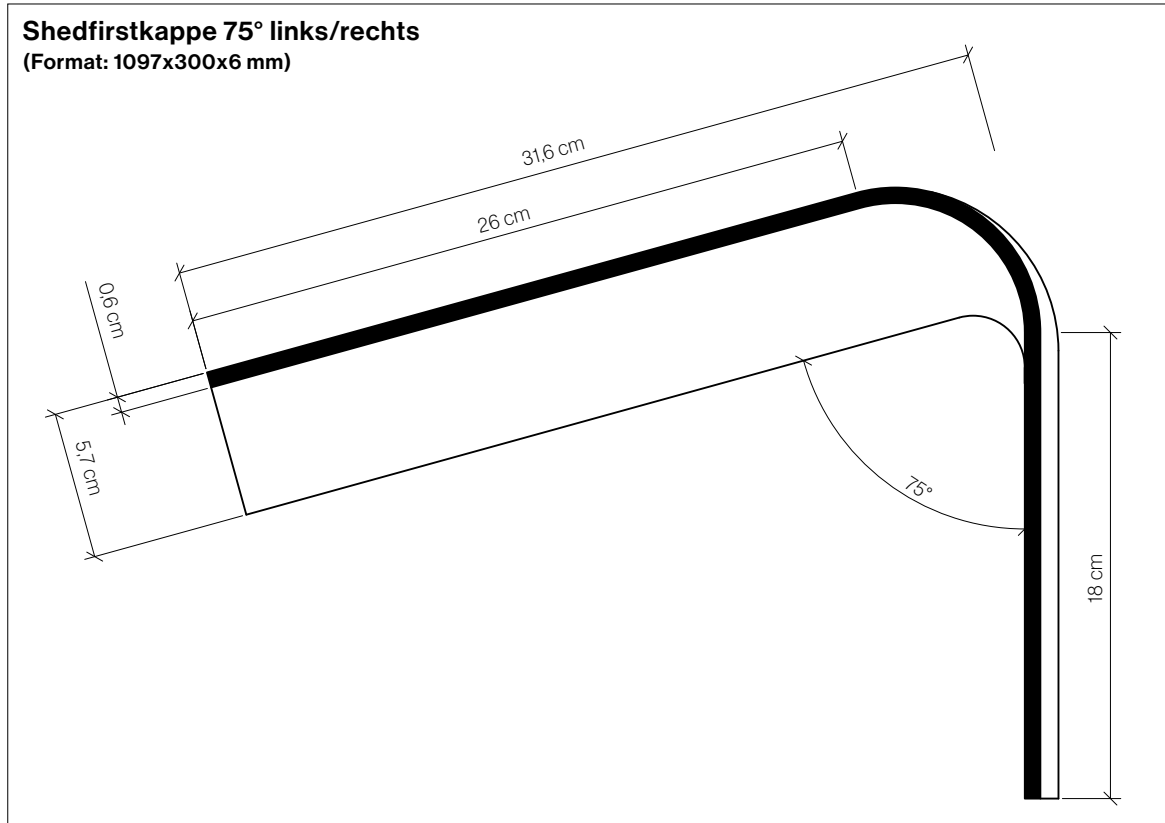

Universal - Übergangsstein links / rechts
(Format: 300x1097x6 mm)

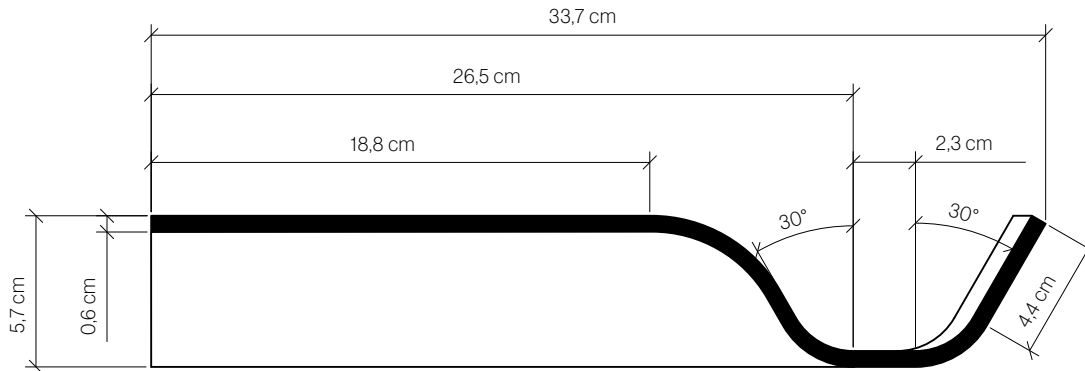



Entlüftungsfirststein

(Format: 2200x280x6 mm / Nutzlänge: 2100 mm)

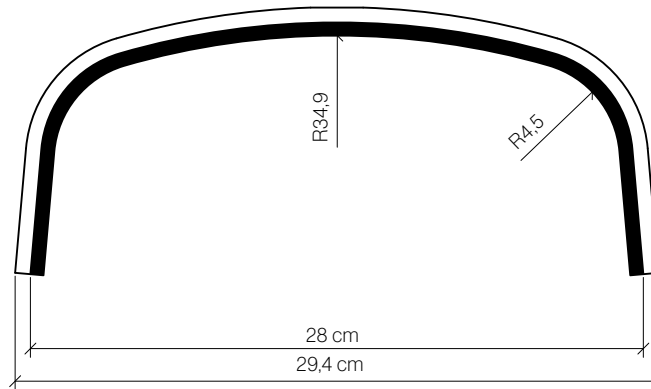

Gratstein und Gratsteinansetzer
(Format: 580x200x6 mm / Nutzlänge: 500 mm)

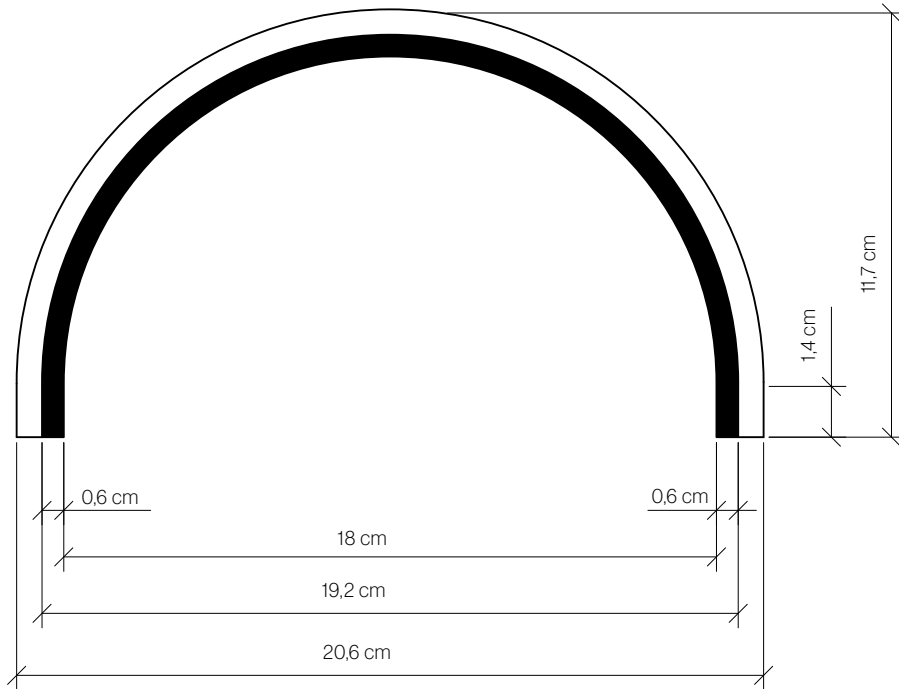



Giebelabschlussstein - rechts (Ortgang - links)
(Format: 2100x220x6 mm / Nutzlänge: 2000 mm)

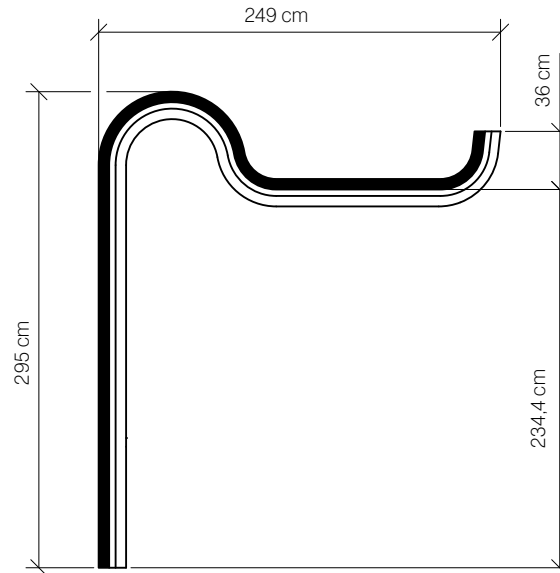

ACHTUNG! Bei Bestellung Giebelabschlussstein - rechts angeben

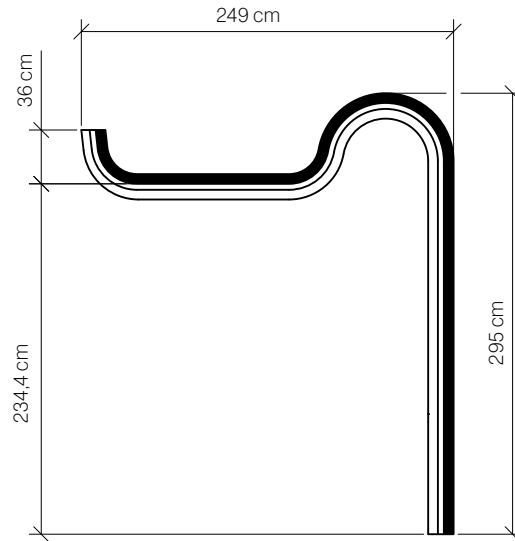
Giebelabschlussstein - links (Ortgang - rechts)**(Format: 2100x220x6 mm / Nutzlänge: 2000 mm)**

ACHTUNG! Bei Bestellung Giebelabschlussstein - links angeben



SWISSPEARL

www.swisspearl.com