

DIM Design & Installation Manual

Facade on Steel – Swisspearl Patina Design Line

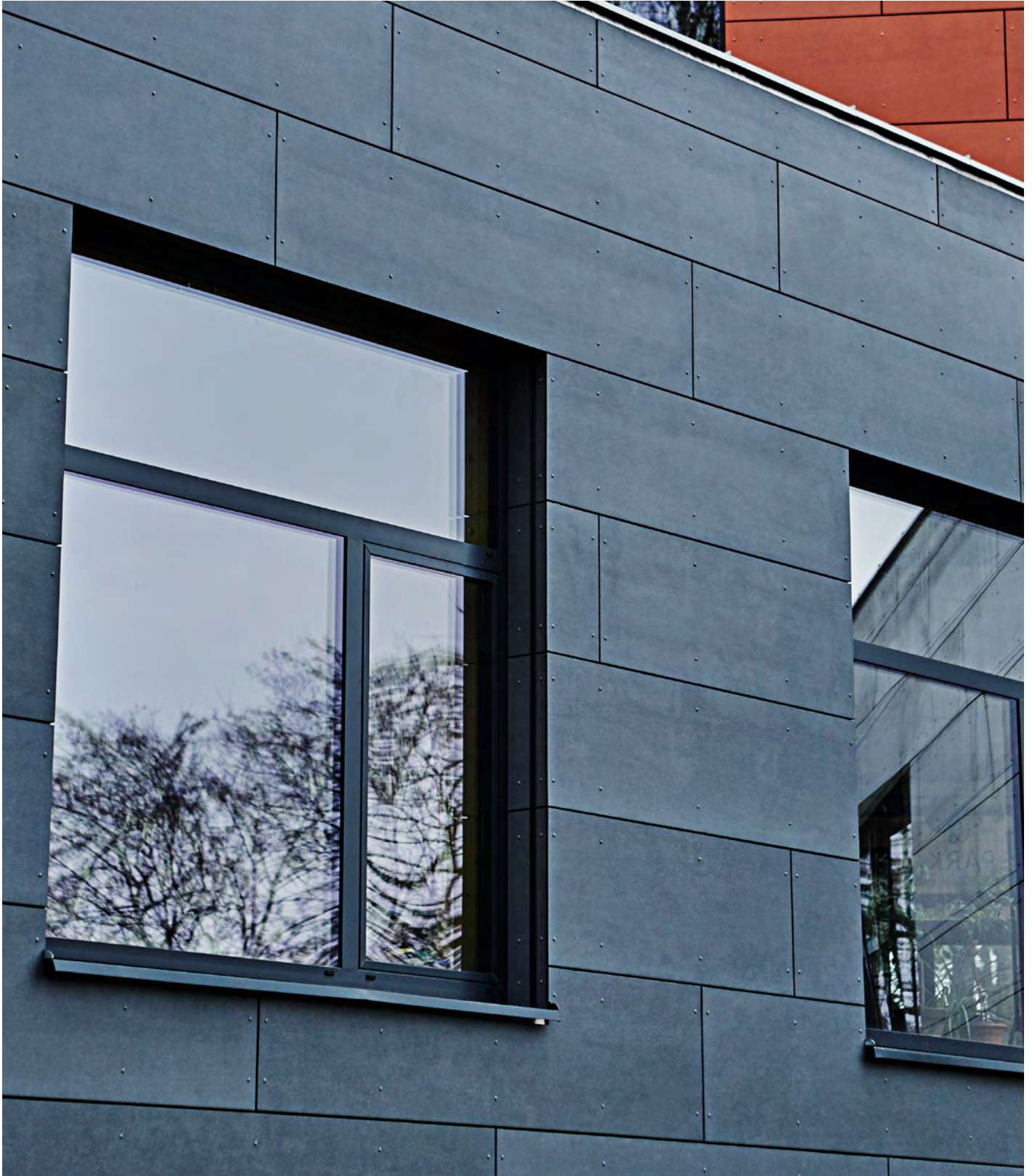



Content

Swisspearl	4
The Self-ventilating Facade	6
Product Range	8
Installation	9
Accessories	23
Storing and Handling	29
Care and Maintenance	30
Health and Safety	32
Onsite Handling	33

Swisspearl

Swisspearl

Swisspearl is one of the leading European manufacturers of multi-capability fibre cement building products. Our products and solutions add exciting new design opportunities for moulding attractive, durable settings for people's lives. But Swisspearl is more than mere products. We also help make all kinds of design and construction projects easier as well as more profitable, inspiring and effective. And for us, all construction also involves building relations with people, making your day better, and helping you make the day better for others.

Product Information

Swisspearl fibre cement is a modern building material made from natural and environmentally friendly raw materials. The technology has been developed by Swisspearl, having more than 90 years of experience within the manufacture of fibre cement. Our wide experience ensures a sustainable product which has accumulated all the advantages of fibre cement. The facade range can be used in all self-ventilated light weight facade constructions. Featuring properties such as non-combustibility, sound and weather insulation as well as high impact strength, Swisspearl fibre cement boards are the ideal facade material.

Quality

Swisspearl product specifications and classifications comply with EN 12467:2012 and 13501-1:2007 + A1:2009

The facade range

- is manufactured in accordance with the quality management system ISO 9001:2015
- complies with the provisions set out in the Construction Products Regulation (UE) No. 305/2011

Product warranty

Warranty conditions are available on request from your local Swisspearl office or dealer.

Note!

The following limitations exist for the Swisspearl Patina design line

Do not use the following facade constructions: Sloped facade with deviation over 5 degrees from vertical, curved facade or non ventilated facade.

Disclaimer

The information and recommendations contained in this Design & Installation Manual ("DIM") are offered as a service to architects, constructors, installer and other persons involved with our products and are not intended to relieve them from their own responsibility. The information and recommendations provided herein are believed by Swisspearl Group to be accurate at the time of preparation of this DIM, or obtained from sources believed to be generally reliable. Swisspearl Group makes no warranty concerning the accuracy of the content of this DIM and shall not be liable for claims relating to any use regardless of whether it is claimed that the information or recommendations are inaccurate, incomplete, or otherwise misleading. The information and recommendations herein are intended to be used with the judgment and experience of professional personnel competent to evaluate the significance and limitations of the material contained. Swisspearl Group expressly disclaims any guarantees or warranties, expressed or implied, for anything described or illustrated herein and assumes no responsibility or liability for damages of any kind, including – without limitation – bodily harm, injury or damage to property inferred from this DIM or the use of the materials described herein.



The self-ventilating facade

A self-ventilating facade is a construction which helps minimise temperature variations in the wall throughout the year. Sunlight and heat are reflected away in the summer-time, and insulation behind the facade boards reduces heat loss in lower temperatures. At the same time, the natural ventilation passing through the construction minimises condensation.

The self-ventilating facade has additional features and benefits. The most important benefit is the protection of the underlying construction against weather, wind and moisture. Some moisture passes through the facade, but it is limited to a level that can either be drained away or eliminated by natural ventilation.

The drainage feature of the system works when rainwater or moisture penetrates through the gaps in the facade. The moisture runs down either the reverse of the facade boards, the windstopper, or the insulation. There should be ventilation openings at the base of the structure and above doors and windows. These openings will also help drain the water away from the construction.

The natural ventilation works by means of a chimney effect. The air enters at the bottom of the structure and on its way up through the facade takes moisture-laden air through the ventilation openings at the top of the structure or at window or door openings.

The boards can be installed with open horizontal joints or with joint profiles. Horizontal joints between boards contribute minimally to natural ventilation and therefore profiles can be used in these joints, if required.

Swisspearl recommends increasing the ventilation area behind the facade boards when installing facade boards on taller buildings. In the table below, it is showing the recommended minimum ventilation cavities behind the facade boards.

Cladding height	min. gravity
<6 m	20 mm
6-20 m	30 mm
>30 m	40 mm

Aluminum construction on heavy wall

1. Swisspearl facade board
2. EPDM
3. Steel profile / Swisspearl VFL profile
4. Ventilaret areal minimum 20 mm
5. Cembrit Windstopper
6. Load bearing wall

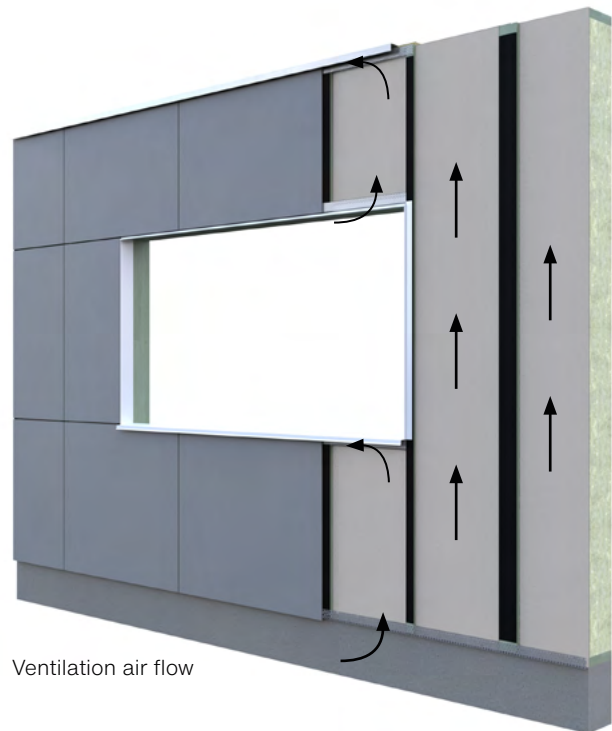

Ventilation air flow

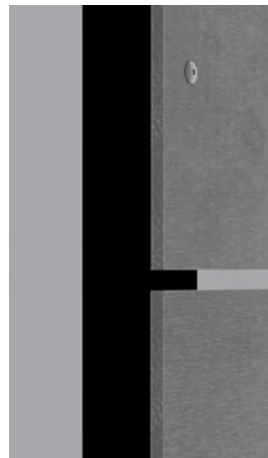

Open joints



Joint profile

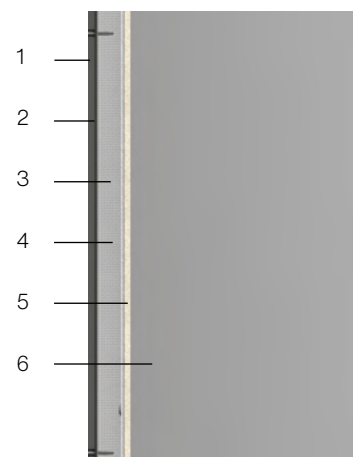

The self-ventilating facade

Ventilated openings

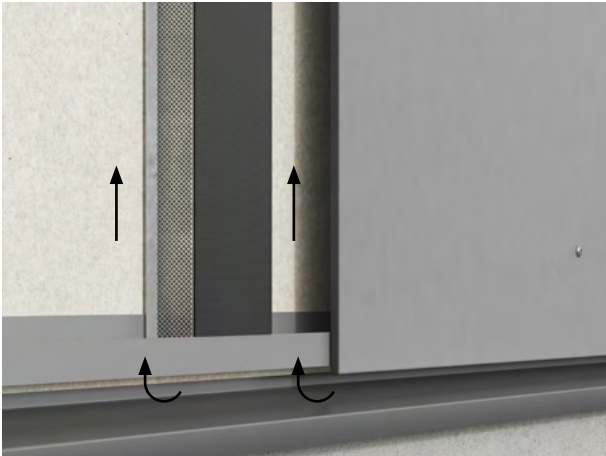

Ventilation at the base

Air is pulled into the construction through an opening at the base of the facade, and it must be ensured that unobstructed ventilation is possible throughout the facade's height. There should be a ventilation gap of minimum 10mm, or equivalent 100cm² per meter. If perforated profiles are used, a ventilation area opening of minimum 100cm² per meter is required. The opening at the base is also used to drain moisture that has entered the facade.



Ventilation at the top of the facade

The passage of air must be maintained at the top of the facade whether it abuts to a roof or other structure. Just as at the base, there must be a ventilation gap of a minimum of 10mm or 100cm² per meter.



Ventilation under windows

A horizontal ventilation opening of minimum 10mm or equivalent to 100cm² per meter should be maintained beneath windows or other openings where a sill is used. This ventilation gap is usually formed between the top edge of the facade boards and the bottom edge of the sill. It is recommended that the sill projects a minimum of 30mm beyond the front of the facade. This ensures that the water running from the sill does not enter the structure.

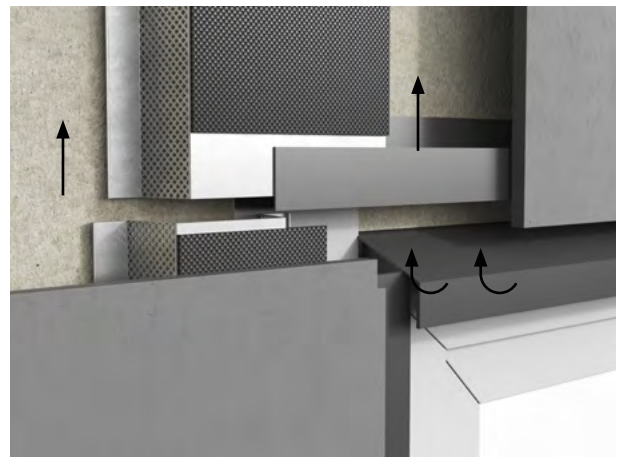

Ventilation above windows and doors

A horizontal free ventilation opening must be maintained above windows and doors as well. This ventilation gap must be at least 10mm wide. If steel, aluminium or plastic perforated profiles are used, a ventilation area opening of minimum 100cm² per meter is required. The opening at the base is also used to drain moisture that has entered the facade.

Product Range

The Swisspearl Patina design line

Swisspearl Patina Original

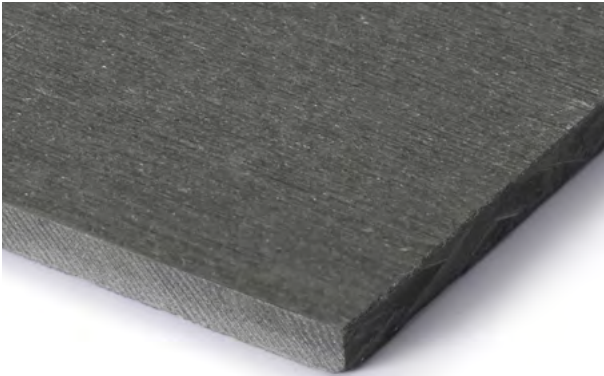

Swisspearl Patina Rough

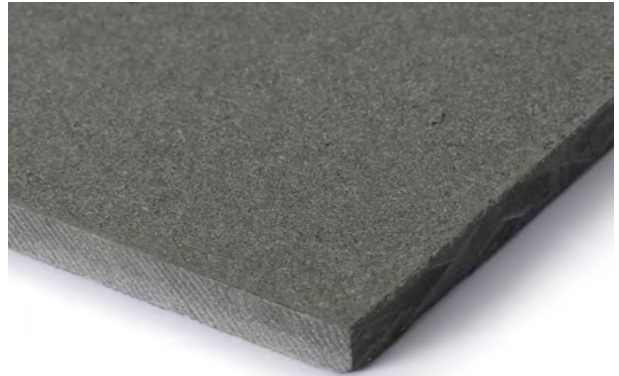

Swisspearl Patina Inline

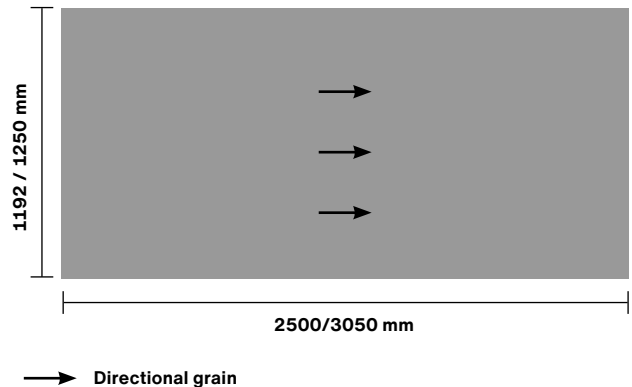

Directional grain

Swisspearl Patina's manufacturing process gives the boards a unique surface texture. This unique finish is enhanced by a process which adds a directional grain to the board - leaving the boards with a different appearance dependent

on lighting and the angle of the board. By rotating boards within the facade makes it possible to obtain a playful visual effect - depending on the viewer's position and the lighting conditions.

Quick facts	Type	Fire class	Thickness	Dimensions	Weight/m ²
Swisspearl Patina Original Swisspearl Patina Rough	Through coloured	A2,s1-d0	8 mm	1192x2500 mm 1192x3050 mm 1250x2500 mm 1250x3050 mm	12.1 kg/m ²
Swisspearl Patina Inline	Through coloured	A2,s1-d0	9.5 mm	1192x2500 mm 1192x3050 mm 1250x2500 mm 1250x3050 mm	14.1 kg/m ²

Installation

Steel substructure

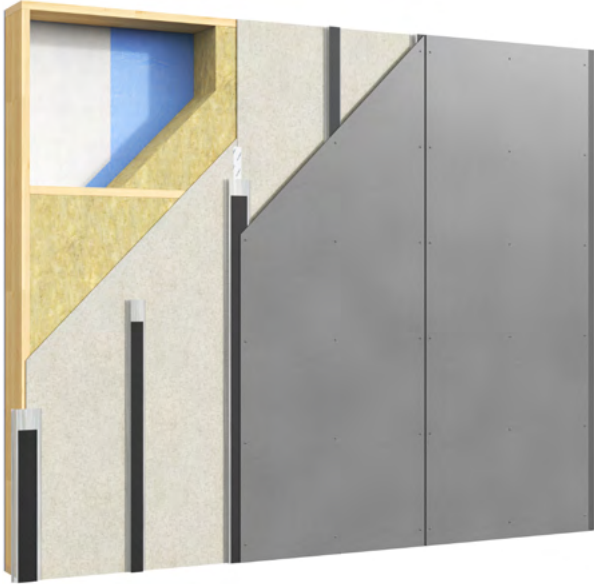

Light wall with vertical VFL steel profiles



Light wall with horizontal VFL steel profiles

Swisspearl Facade boards can be installed on different types of steel profiles an support systems.

All drawing and descriptions in this manual is with the assembly of Swisspearl Facade boards on Swisspearl VFL steel profiles. Swisspearl Facade boards can also be installed on other types of steel profiles. If other types of profiles is used, then the overall installation principles both regarding the steel installation and the facade boards installation must be followed.

Swisspearl facade boards can be attached to a steel profile with either Swisspearl facade rivet or Swisspearl facade screw. Swisspearl recommends a minimum steel thickness of at least 1 mm. Swisspearl Facade boards must not be installed on steel profiles having a length over 3050mm.

Swisspearl VFL profile installation

Swisspearl VFL profiles can be used on lightweight wall constructions or installed directly on a heavy wall. The VFL profiles are perforated so that they can be installed both horizontally or vertically (see above). When installed horizontal, the perforated holes will allow the air to pass and this way the construction will still be ventilated behind the facade boards.

Attaching VFL profiles to the wall

Fastening of Swisspearl VFL profiles must be done with two screw / fastening at each fastening point, this is done to ensure that the profile will not twists (Fig. 1). For that reason, it will require horizontal structure for vertically installed Swisspearl VFL profiles. Securing the profiles to the load-bearing wall must comply with all local standards and regulations as well as follow the manufacturers' recommendations. Before installing on a loadbearing wall, the installer should check to ensure that wall is flat and true and that the support system can be mounted safely.

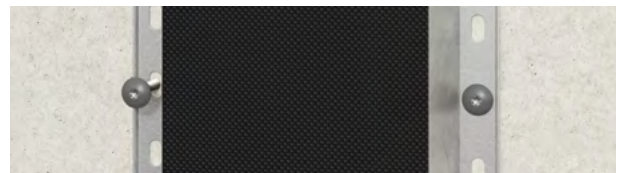

Fig. 1

To select the correct screw / fastening solution for Swisspearl VFL profiles the following must be taken into consideration.

- Screw / fastening must match the type of wall on which Swisspearl VFL should be installed.
- Corrosion resistance must be taken into account to be sure to used the correcttypes relation to the surroundings.
- A calculation must be made or a assessment of the wind load should be made

Based on these parameters, a screw / fastening is then selected.

Installation

Steel substructure

To ensure the optimum, long term performance and aesthetic characteristics for Swisspearl facade boards it is vital to ensure that the support system substructure is absolutely straight, horizontally and vertically. In order to ensure this, please follow the guidelines below.

Straightness of substructure

The horizontal tolerance is +/- 3.0mm measured over a distance of 2 meters

The vertical tolerance is +/- 1.0mm over 600mm measured over a distance of 2 meters.

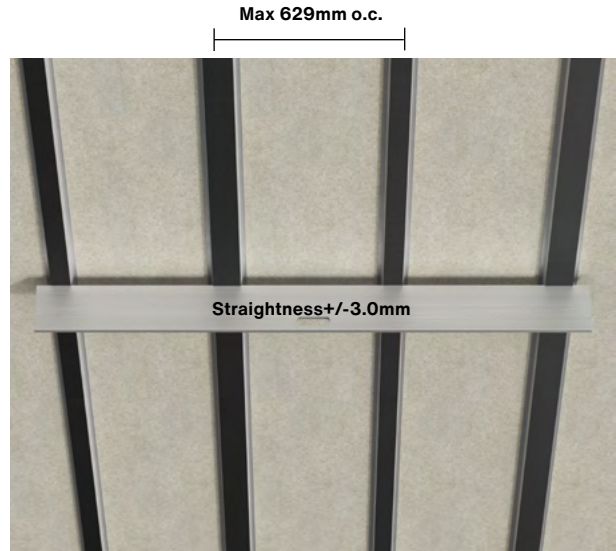

Straightness of substructure

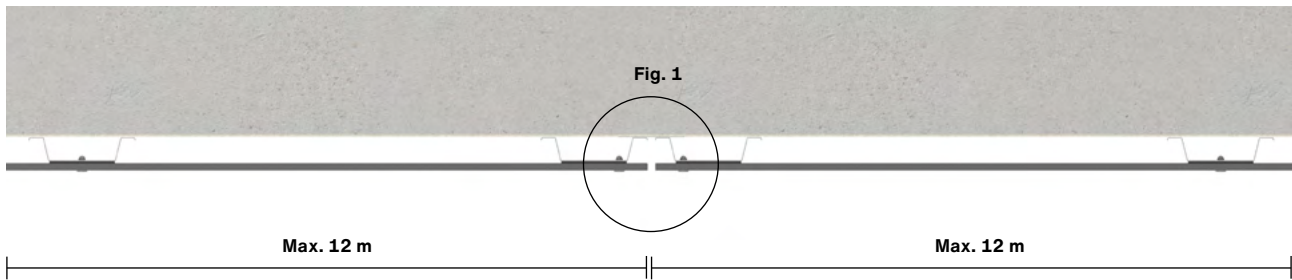

Movement joints

When installing Swisspearl facade boards using steel support systems over a large area, the movement of the facade boards and the support system must be taken into account.

Instead of using large VFL or Omega profiles at joints, use separate profiles to create a movement joint. This ensures that the two facade sections can move separately.

These joints should be included every 12 meters maximum. The movement joint gap (between the two facade sections) should be minimum 8mm (Fig.1)

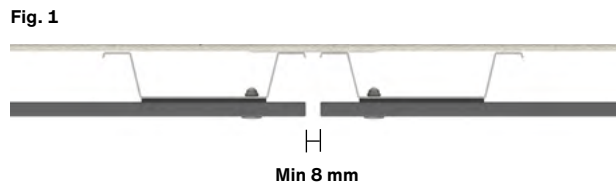

Installation

Steel support system fixing



Fixing points (F) Sliding points (S)

Steel support system fixing and sliding points

Since the steel will expand or contract according to climatic conditions, the steel profiles should be secured using fixing points. The remaining fasteners should be fixed using sliding points. This allows the profiles to move up and down as the steel expands or contracts. The fixed point should be placed as close to the center of the profiles as possible so the profiles can move in both directions. The example shown above illustrates a construction where the fixing points are positions as close to the middle. Only when there are 2 fasteners, the fixing point should be in the top, so that the profile can only move from the top downwards.

The screws used for the fix point shall be installed between the elongated holes in the profile flange (Fig.1). Use either a self-tapping screw which can drill itself through the steel or if the substructure is of wood then pre-drilled in the profile with a drill having a diameter corresponding to it selected screw.

All the additional fasteners, is installed in the elongated holes (Fig.2 sliding points) in the flange of the profile. The fasteners is placed in the middle of the elongated hole so that the profile thereby has possibility to work to both sides (Fig. 2). The facade boards may only be installed on VFL profiles where the fixed points are at the same level.

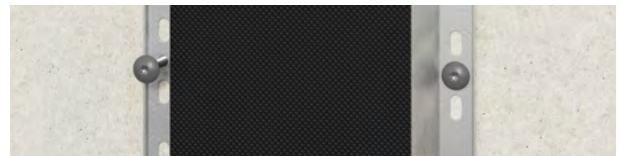

Fig.1. Fixing points: Swisspearl VFL profiles are installed with fastener between the elongated holes

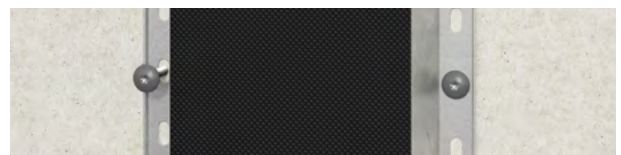

Fig.2. Sliding points: Swisspearl VFL profiles are installed with fastener in the center of the elongated holes

Installation

Steel substructure

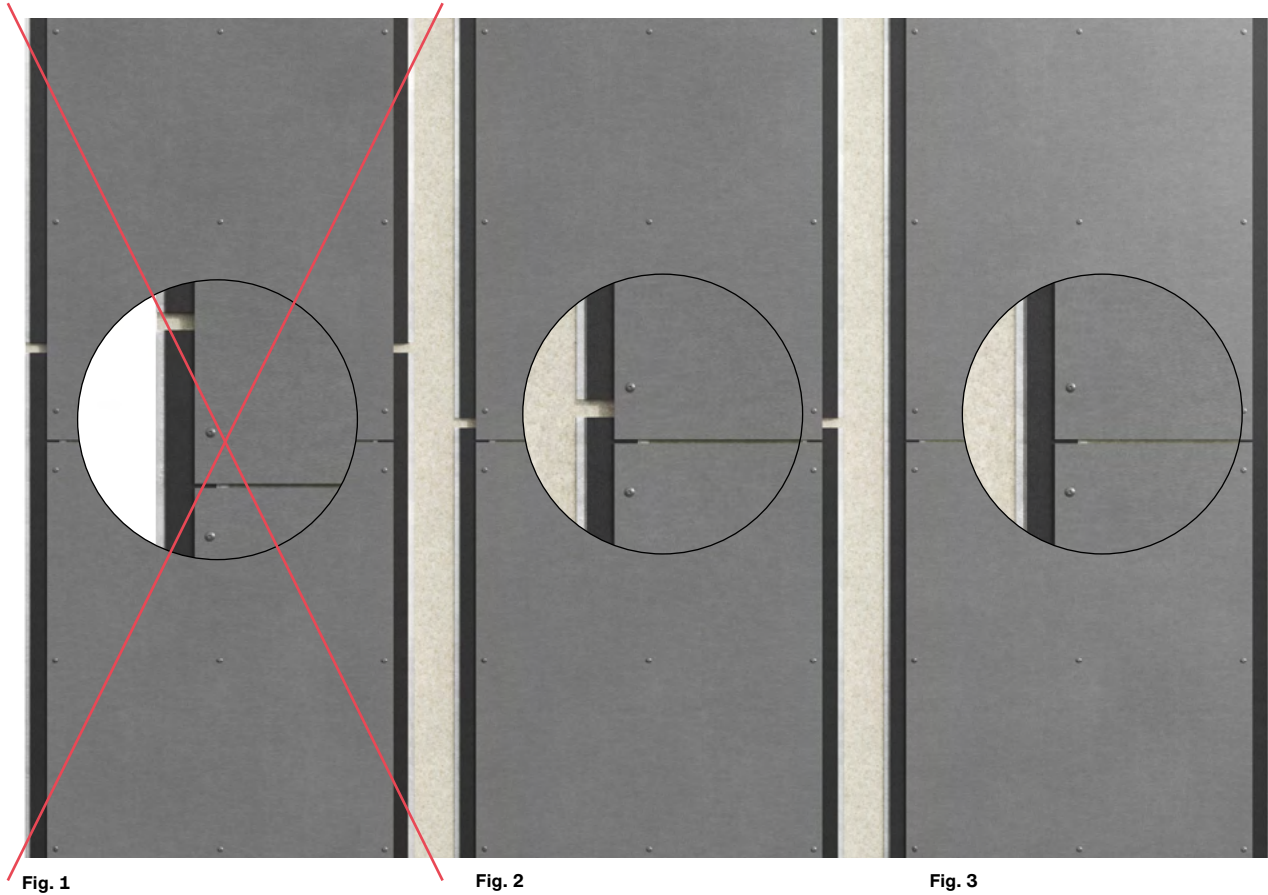

Fig. 1

Fig. 2

Fig. 3

Correct installation of the steel support system Never install Swisspearl facade boards spanning over two or more steel profiles lengthwise, as movement of the steel and the facade boards caused by moisture and temperature changes potentially could damage the boards (fig. 1).

Swisspearl facade boards can either be installed to match the module length of the support system profiles (fig. 2), or smaller format boards can be installed so that several boards span the same profile (fig. 3), provided that facade boards are not fixed to two separate support profiles.

Ensure a minimum 20mm gap between the steel profiles (fig. 4).

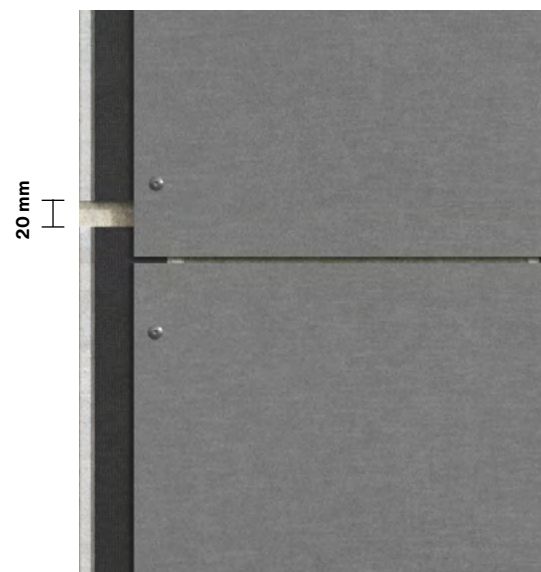

Fig. 4

Installation

Edge Distances

There should be a minimum of 20mm from the reverse of the facade board to the front face of the Windstopper or insulation to provide adequate ventilation. The profiles behind joints should be min 100mm width (Fig. 1), and the middle profiles should be min 40mm width (Fig. 2). Joint gaps between boards should be min 8mm and max 16mm.

Always use EPDM on steel profiles as it will provide adequate protection of the boards from moisture movements. From an aesthetic point of view, including the EPDM will also make the steel profiles less visible through the joints. Swisspearl facade boards can also be installed on horizontal steel profile systems. When using a horizontal Swisspearl VFL profile, the profiles can be mounted directly on the wall since it is perforated and the air can move freely. If using other horizontal systems, a minimum of 25mm ventilated vertical area between the profiles and the supporting wall or insulation must be ensured.

To ensure that boards are able to accommodate movement without damage, please adhere to the following Swisspearl guidelines for correct fixing centres and hole sizes. Holes should be pre-drilled using a 9mm drill bit for rivet and a 8mm drill bit for screws (for fibre cement).

The position of the corner hole is dependent on the direction of the support system.

Fixing distances from the board edge, in the direction of the support system, should be minimum 100mm up to max 150mm.

Fixing distances from board side edges should be min 30mm and max 100mm.

The illustrations show a vertical support system. If using horizontal support system, the corner distances should be reversed.

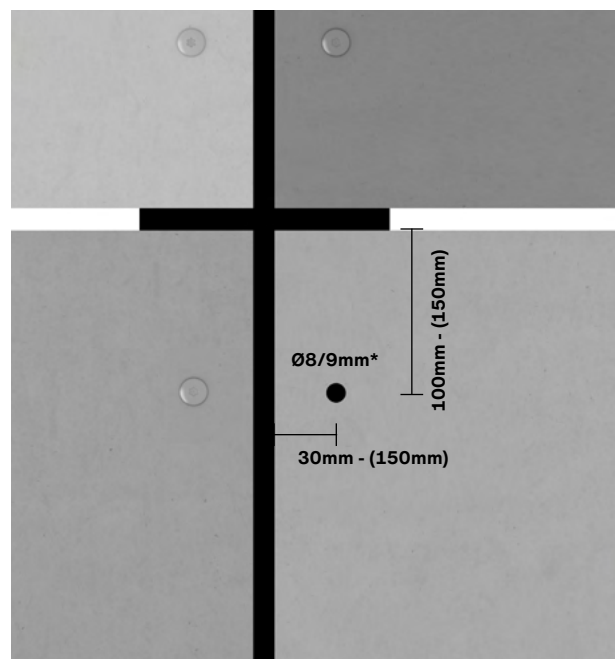
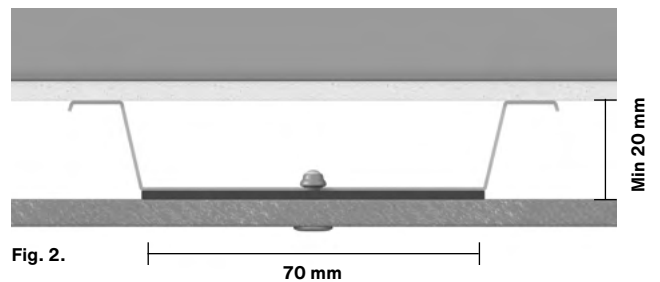
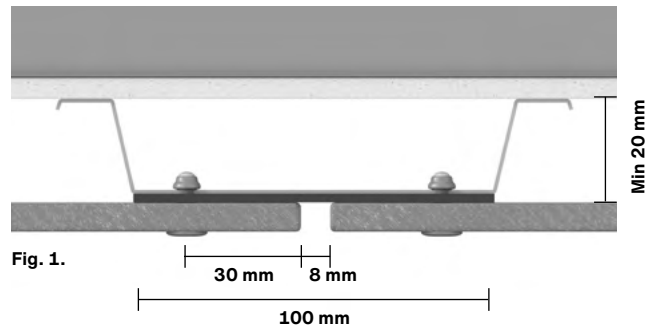

Example of vertical substructure

* 9mm drill bit for rivet and a 8mm drill bit for screws

Installation

Steel substructure



Swisspearl facade boards installed on vertical VFL profiles



Swisspearl facade boards installed on horizontal VFL profiles

Steel support system

Mounting 8mm Swisspearl facade boards on steel

Max support distances:
629mm o.c.

Max rivet centres: 600mm

Max wind load: Please refer to the wind load table for the correct distances for substructure and rivets.

The following rivet and screw types can be used for this construction:

- Swisspearl Rivet Steel RIV-S 4.8x20mm
- Swisspearl SCR-S 4.8x29mm

Installation

Edge distances

Swisspearl Patina Inline

Swisspearl Patina Inline is available in four dimensions:
1192x2500/3050mm
1250x2500/3050mm

Please note that the 1192mm and 1250mm board cannot be combined as the widths of milled lines are slightly different.

Make sure to adhere to the installation principles in this manual when installing Swisspearl Patina Inline. The areas in which the installation of Swisspearl Patina Inline differs from the normal installation method will be explained below. Pre-drill the Swisspearl Patina Inline board using a $\varnothing 8$ mm drill for screws and $\varnothing 9$ for rivets - suitable for fibre cement.

Edge distances

The edge distance of the hole is dependent on the direction of the support system - as the normal installation principles.

- Edge distances from the board end, in the direction of the support system, should be minimum 100mm up to max 150mm
- The edge distance from the board side edges should be minimum 30mm and max 100mm

If the board is mounted with horizontal lines as in fig. 3* the edge distance should be minimum 100mm, but as the milled lines will not necessarily match the edge distance, it should be placed at the nearest following top line.

If the board is mounted with vertical lines as in fig. 3** the edge distance should be minimum 30mm for full size boards. If cut to size, please refer to the paragraph below. Please note that the screw or rivet should always be mounted at the top of a line and centred (fig. 1). The same applies to the installation on central battens (fig. 2).

Edge distance of cut to size boards

If the board is cut to size to be installed in connection with windows, doors or similar, it may not be possible to keep the edge distance at 30mm due to the nature of the lines. It will be necessary to place the screw at the following top instead (fig. 4).

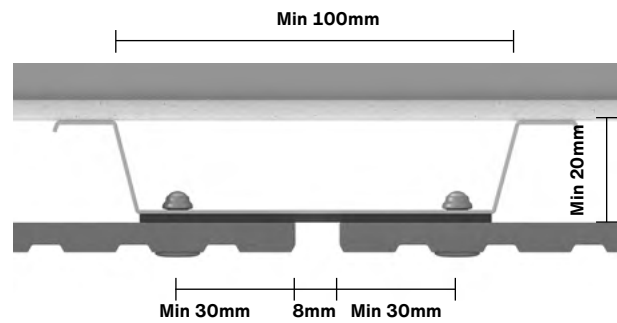

Fig. 1. Swisspearl Patina Inline installation on profile behind joint.

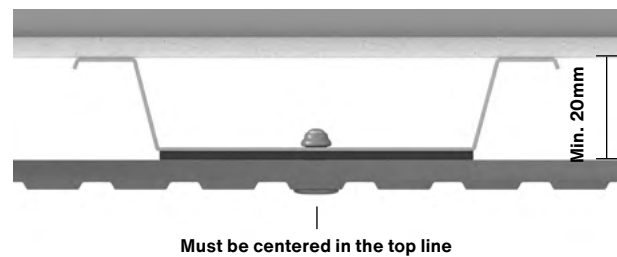

Fig. 2. Swisspearl Patina Inline installation on the middle profile.

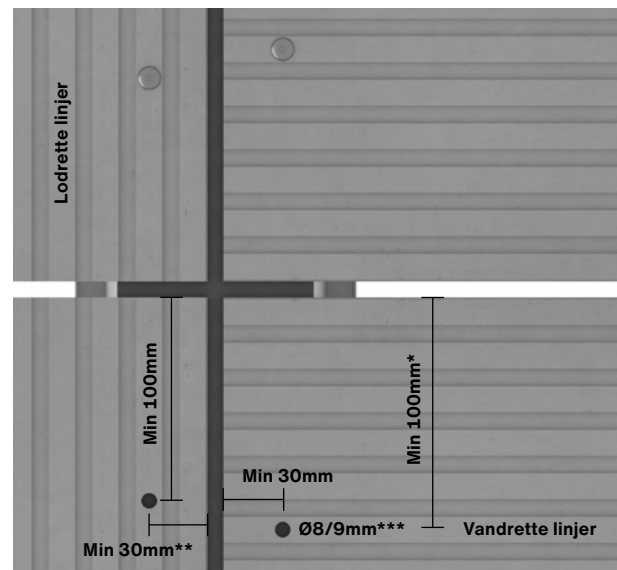

Fig. 3. Swisspearl Patina Inline edge distances.
Note! Min distance and/or the nearest following top line.
***9mm drill bit for rivet and a 8mm drill bit for screws.

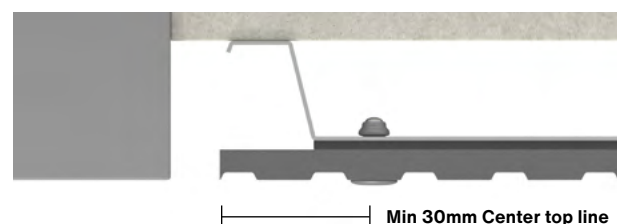

Fig. 4. Swisspearl Patina Inline installation on cut to size board.

Installation

Wind load

Swisspearl Patina Design Line

When installing Swisspearl facade boards, consideration should be given to the location of the building and which wind load the boards can be exposed to. In the table below, you find the screw distance as well as the support distances. Combining these two shows how much the board can withstand in kN/m². It may be necessary to change support spacings/rivet distances at edge zones as the wind loads here may be higher than elsewhere on the building.

Swisspearl Patina Design Line - Rivet - characteristic values

Maximum rivet distances mm	Maximum batten distances mm			
	300	400	600	629
300	12.14 kN/m ²	7.95 kN/m ²	3.53 kN/m ²	3.21 kN/m ²
400	9.11 kN/m ²	6.83 kN/m ²	3.53 kN/m ²	3.21 kN/m ²
500	7.29 kN/m ²	5.47 kN/m ²	3.53 kN/m ²	3.21 kN/m ²
600	6.07 kN/m ²	4.55 kN/m ²	3.04 kN/m ²	2.90 kN/m ²

Swisspearl Patina Design Line - Screw - characteristic values

Maximum Screw distances mm	Maximum batten distances mm			
	300	400	600	629
300	9.99 kN/m ²	7.49 kN/m ²	3.53 kN/m ²	3.21 kN/m ²
400	7.49 kN/m ²	5.62 kN/m ²	3.53 kN/m ²	3.21 kN/m ²
500	5.99 kN/m ²	4.50 kN/m ²	3.00 kN/m ²	2.86 kN/m ²
600	4.99 kN/m ²	3.75 kN/m ²	2.50 kN/m ²	2.38 kN/m ²

The calculations are based on ETAG 034. No additional safety factors have been added. The test underlying the calculations is made by an Accredited Laboratory and with Swisspearl's facade screws/rivets and substructure described in the manual. The steel used in the substructure complies with EN 10088 EN 10088 (e.g. 1.4401, 1.4404, 1.4571).

If other types of rivets and screws are used, Swisspearl cannot vouch for the numbers in the chart. For high buildings or buildings located in exposed areas, there may be a need for specific wind load calculations and simulations, in which case you can contact Swisspearl for further information. There may also be situations where additional support and screws are needed in edge zones of the building. The wind load calculation should always be done according to local rules, regulations and the substructure has to be installed correctly as well, so it can withstand the wind load.

Installation

Fixing points for Swisspearl facade boards

To make the installation on steel easier, Swisspearl facade boards should be installed using two fixing positions and all other positions should be sliding points. These positions should be as close to the board centre as possible and must be aligned horizontally.

When installing Swisspearl facade boards using rivets/screws, begin with the fixing positions, followed by the sliding points above the fixing positions and finally the sliding points below (see illustration below)

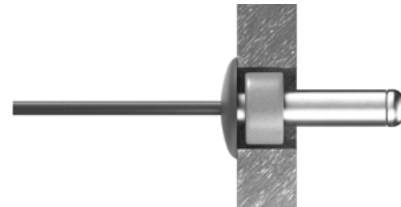

X : Fixing position hole diameter $\varnothing 9$ mm.
Insert a Swisspearl Fixing Sleeve in the hole before the rivet is fixed.



X : Fixing position hole diameter $\varnothing 5$ mm.

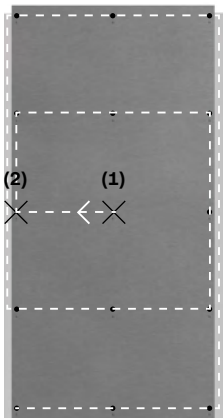
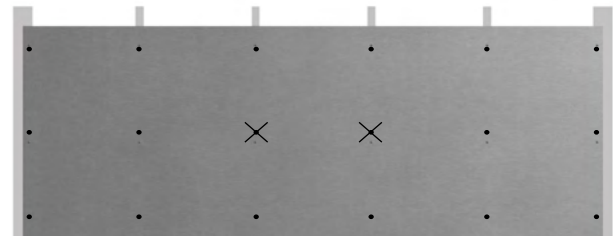
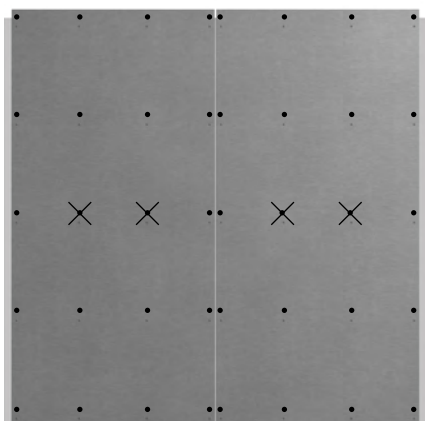

Illustration of correct rivet installation sequence. 1 and 2 are fix points



Example: Horizontally mounted boards with four intermediate steel profiles



Example: Vertically mounted boards with two intermediate steel profiles

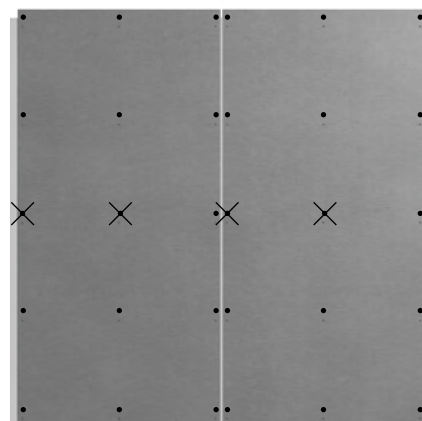

Example: Vertically mounted boards with one intermediate steel profile

Installation

Swisspearl facade boards used as ceiling or soffit

Swisspearl facade boards are ideal for use as ceilings and soffits. The solution can be used for both exterior and interior applications.

The boards can be installed on profiles directly mounted to a concrete deck or wooden structure, or they can be used as part of a solution with a suspended ceiling system. It is possible to change or remove the Swisspearl facade boards to access any hidden installations as the boards are mounted using visible rivets/screws.

Installing 8mm Swisspearl facade boards on a steel structure - as ceiling or soffit

Max support distances: 400mm o.c
Max screw/rivet centres: 400mm

The edge distances when using Swisspearl facade boards as ceiling or soffit are in principle the same as for facade boards in which the direction of the substructure and the orientation of the board define the edge distances. This also applies to hole sizes, joints and distances to other building materials.

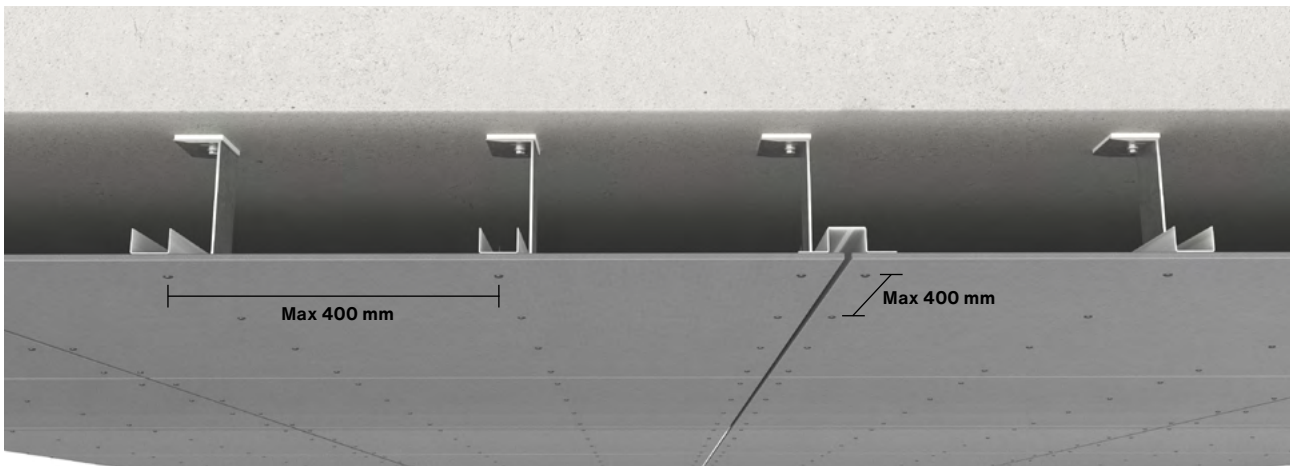

When using Swisspearl facade boards as ceiling or soffit, you can normally use a regular steel system with steel profiles, but for larger cavities, you need to contact a steel manufacturer to make sure the system fits your needs. The number of brackets and types of anchoring used for the type of deck/ceiling has to be calculated, and the manufacturer's instructions should always be followed.

Installation

Cut outs

To avoid cracking of the boards (Fig. 3), when installing Swisspearl facade boards around windows, doors and other openings, ensure that the facade boards are installed correctly using Swisspearl's instructions. Swisspearl recommends to avoid cutting single (Fig. 3), exact apertures in boards, but instead you should cut smaller sections and install them individually. Cut the boards and make vertical joints of 8mm. Make sure that there is support behind the joints, onto which the facade board can be mounted.

If the small cut outs are not wider than 100-150mm (Fig. 1), they can be mounted with only one rivet/screw in the middle of the board (a). This also applies when using the Swisspearl facade boards in other solutions on a building as window jambs or in connection with other narrow spaces.

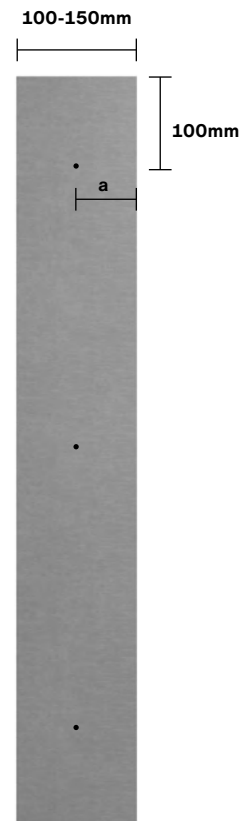

Fig. 1

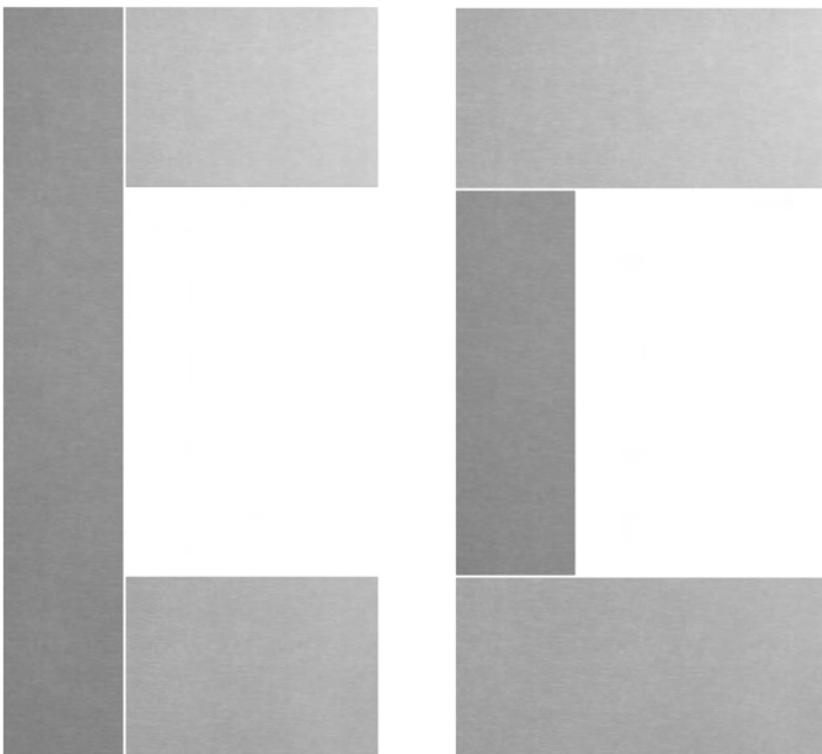

Fig. 2. Correct installation of Swisspearl facade boards at windows, doors and openings.

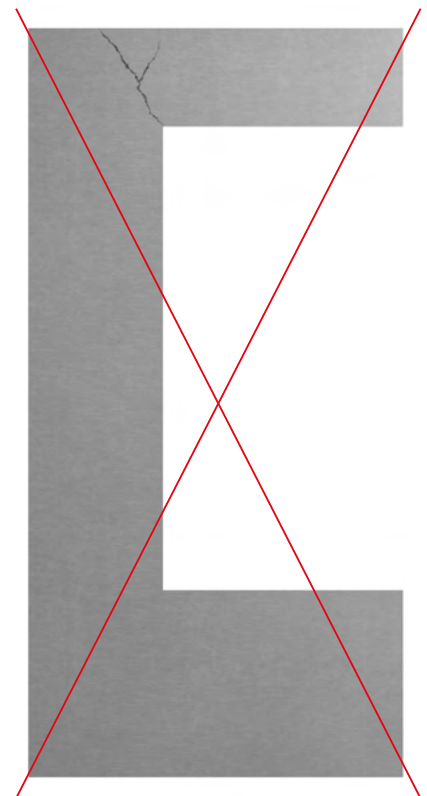
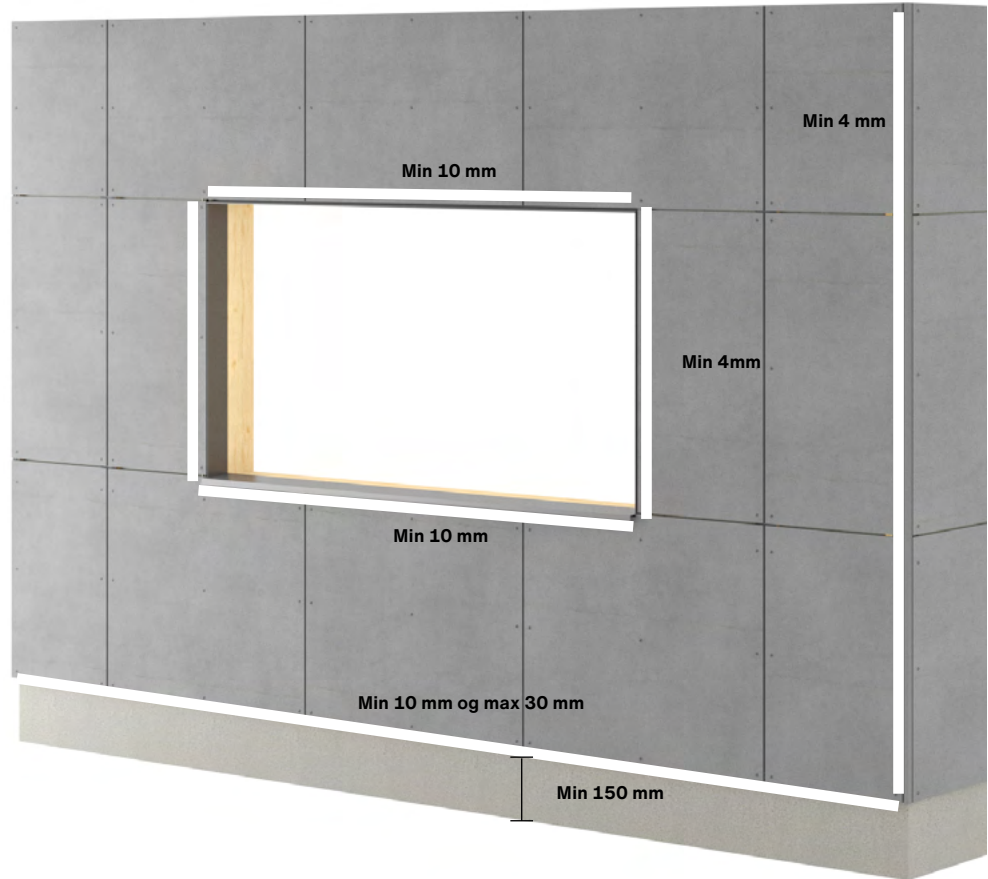

Fig. 3. Incorrect installation of Swisspearl facade boards at windows, doors and openings.

Installation

General distances



Follow the guidelines regarding distances described in this manual. The facade board should finish between 10 and 30mm below the bottom end of the substructure. For overhang and similar, the maximum distance is 100mm.

The distance to terrain from the bottom edge of the facade board should be a minimum of 150mm. The distance to flat roofs, balconies and other horizontal structures, where the water can drain away, should be a minimum of 50mm.

Vertical clearance to profiles such as Swisspearl Alu Trim or Swisspearl Corner profile should be minimum 4mm. For horizontal clearances at windows and doors etc., you must leave a minimum of 10mm for ventilation.

The clearance to other building materials should be minimum 8mm for movement and water drainage.



Installation

Details

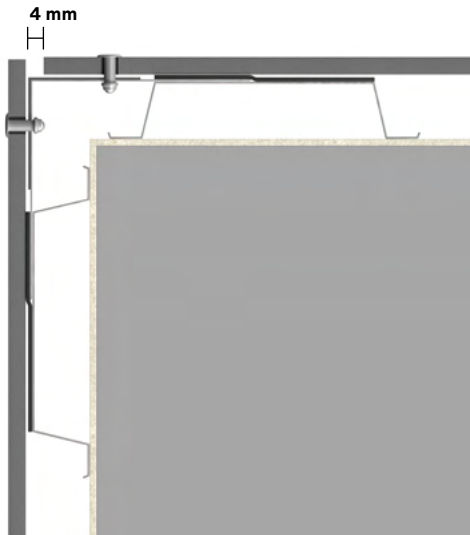

Horizontal view: External corner construction with open joint
It is possible to create an external corner detail without a Swisspearl corner profile. There should be a min. 4mm gap between the facade boards forming the corner joint. If using brackets and profiles, an angle profile can be used behind the facade. It should be fixed with screws or rivets. The distance from the corner to the profile that is fixed to the wall should not be more than 200mm.

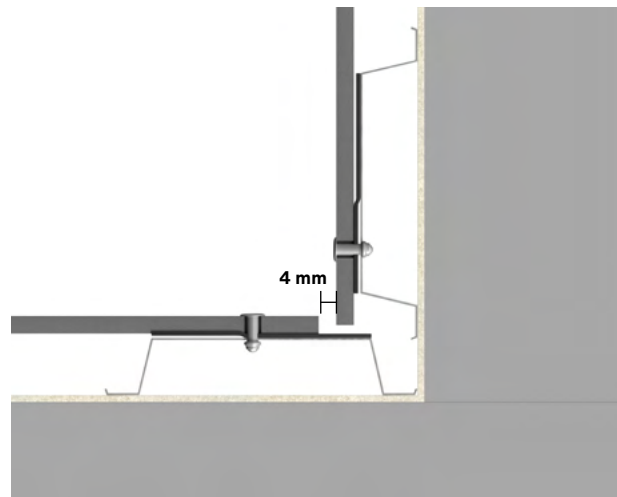

Horizontal view: Internal corner construction with open joint
There should be a min. 4mm gap between the facade boards forming the corner joint.
If you use an angle profile in the corner behind the boards, Swisspearl recommends using a flat EPDM or UV tape to cover the angle profile for aesthetic reasons.

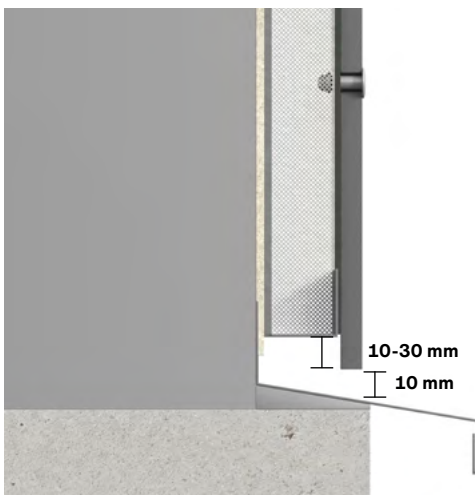

Vertical view: Plinth construction
Ensure that the facade boards project past the base of the support from 10 to 30mm, thereby allowing the water from the facade to run off. Use a ventilation grill at the base of the cladding to ensure that insects and vermin cannot enter the construction behind the facade boards. There should be a minimum free open area of 10mm, or equivalent 100cm² per meter.

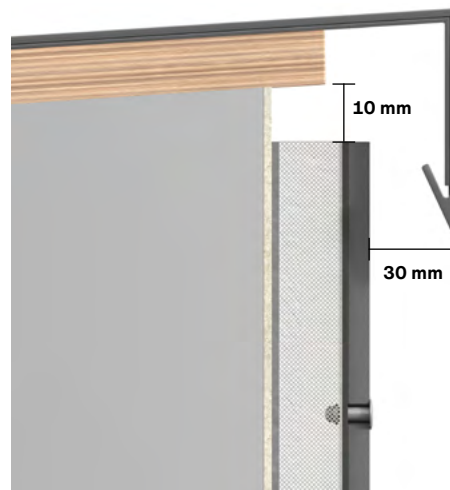

Vertical view: Top construction
Make sure that air can move freely from throughout the construction. There should be a minimum free open area of 10mm, or equivalent 100cm² per meter to provide adequate ventilation throughout the system. There should be a minimum gap of 30mm between the front face of the facade board and the drip edge of the capping.



Accessories

Swisspearl Profiles

Swisspearl offers a wide range of profiles to create weathertight and aesthetically pleasing facades. All Swisspearl Profiles are available in a variety of standard or special colours - either pre-painted or powder coated. The profiles are fixed using double sided tape and will be further fastened as the boards are installed. Most Swisspearl profiles are fabricated from 1mm thick formed aluminium. For standard profiles, the profiles are pre-coated formed aluminium which has a gloss 30. For non-standard colours, the profiles are unpainted formed and powder coated aluminium with a paint of gloss 70. The profiles in standard colours are protected with a sticky foil.

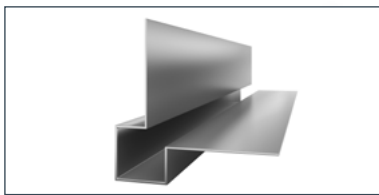

1. Swisspearl External Corner Small
Length 3000mm



2. Swisspearl External Corner Peak
Length 3000mm

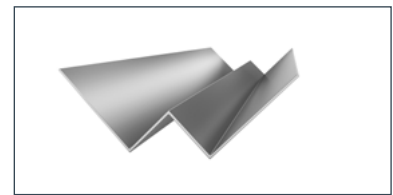

3. Swisspearl Internal Corner
Length 3000mm

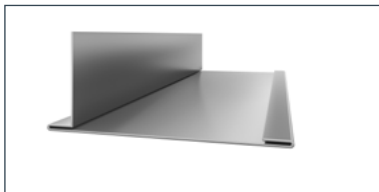

4. Swisspearl Vertical Trim Large
Length 3000mm

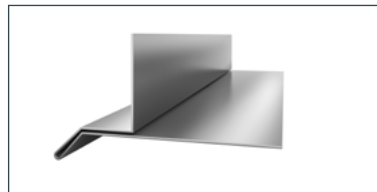

5. Swisspearl Horizontal Trim Small
Length 3000mm

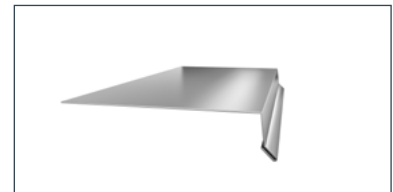

6. Swisspearl Sil
Length 3000mm

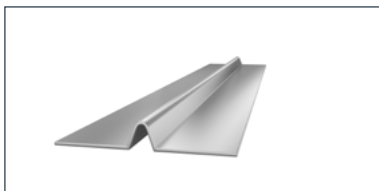

7. Swisspearl Caulking Profile
Length 3000mm



8. Swisspearl Horizontal L Profile
Length 3000mm

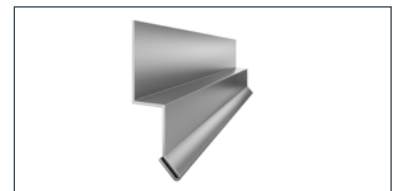

9. Swisspearl Drip Small
Length 3000mm



10. Swisspearl Ventilated Profile
0.6 mm white perforated steel
Length 3000mm



11. Swisspearl Perforated VFL profiles
25x100mm 1mm thickness
25x70mm, 1mm thickness

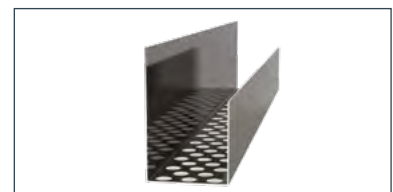

12. Swisspearl Ventilated Wall Profile 40
25x40mm Horizontal ventilation
start-end ptofile, 1mm thickness

Accessories

When fixing Swisspearl facade boards using steel profiles, use purpose-designed accessories. In general, using appropriate tools will achieve the best installation.



Swisspearl Rivets Steel

RIV-A EPDM Washer 4.8x20mm
 Stainless body and Stainless steel mandrel. Unpainted or colour coated to the facade boards
 Grip Range 10-14mm



Tool Box Steel

1. Centralizing Tool for steel
2. Stand-off Head
3. 2 Pcs. HSS Drills 4.9mm
4. TCT Drill 9mm



Swisspearl Facade Screw steel

SCR-S 4.8x29mm
 A2 stainless steel
 (Swisspearl Patina Design Line)



Swisspearl Fixing Sleeve

Sleeve for Steel Rivets
 4.1x5.5x8.8mm Nylon black



Swisspearl Nose tool



Swisspearl EPDM 3x100mm

Swisspearl EPDM 3x50mm
 30 m/roll black



Centralizing Bit Drill

- 4.1/8.5-9 mm

Accessories

Consumption of material

To be able to calculate the consumption of materials when installing Swisspearl facade boards, use the table below for reference. The consumption shown is per board.

Accessories per full sizes facade board						
Width	mm	1192		1250		
Length	mm	2500	3050	2500	3050	
Thickness	mm	8	8	8	8	
Coverage per board	m ²	2.98	3.64	3.13	3.81	
Max distance – battens (o.c)	mm	600	600	629	629	
Wall (Vertical mounted facade boards)	Facade Screw/Rivets	pcs.	21	27	21	27
	EPDM (narrow)	m	2.50	3.05	2.50	3.05
	Numbers of central profiles	pcs.	1	1	1	1
	EPDM (wide)	m	2.50	3.05	2.50	3.05
Wall (Horizontal mounted facade boards)	Numbers of supporting profiles	pcs.	1	1	1	1
	Facade Screw/Rivets	pcs.	21	24	21	24
	EPDM (narrow)	m	3.60	4.80	3.75	5.00
	Numbers of central profiles	pcs.	3	4	3	4
Soffit/Celling	EPDM (wide)	m	1.20	1.20	1.25	1.25
	Numbers of supporting profiles	pcs.	1	1	1	1
	Substructure distances	mm	400	400	400	400
	Facade Screw/Rivets	pcs.	28	36	28	36
	EPDM (narrow)	m	5.0	6.1	5.0	6.1
	EPDM (wide)	m	2.50	3.05	2.50	3.05

Swisspearl Blades

For cutting Swisspearl facade boards, the following blades can be used.

Diameter	Ø160	Ø190	Ø216	Ø250
Thickness mm	2.2/1,6	2.2/1,6	2.2/1,6	2.6/1,8
Centre hole mm	20	20	30	30
RPM	4800	4000	3500	3000
Teeth	6	6	6	14

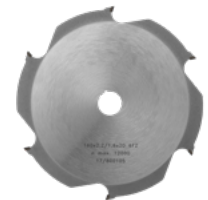

Drill

For pre-drilling of Swisspearl facade boards, please refer to your local Swisspearl office for instructions.

Diameter	8mm
Diameter	9mm

Accessories

Swisspearl Facade Screw

Swisspearl Facade Screws

For Swisspearl Patina design line boards, you should use the Swisspearl Facade Screw SCR-S (Fig. 1) with a Ø12mm mushroom head. For steel profiles substructure, Swisspearl offers the SCR-S screw in three different types; 4.8x29mm for one layer of boards and 35mm for two layers of boards, both can be used in steel thickness 0.7-1.5mm. If thick steel is used then Swisspearl can offer a Swisspearl Special screw SCR-S 5.5x25mm for one layer board mounted on steel thickness from 1.5-6.0mm.

Pre-drilling

For pre-drilling (Fig. 2), it is recommended that you use a drill bit Ø8mm that is suitable for fibre cement. This leaves you with the best results and the optimum number of drilled holes per drill bit. Dust from cutting or drilling must be removed with a brush or compressed air immediately after the work has been completed, otherwise it can mark the surface of the boards.

When applying Swisspearl Facade Screws, ensure that the Swisspearl Facade Screws are centrally located in pre-drilled holes. The screw must be angled 90 degrees (Fig. 3) to the facade board. When inserting the Swisspearl Facade Screw, please be careful not to overtighten the screw - especially near the edges and corners of the boards. Swisspearl recommends using the torque on the screwdriver to avoid over-tightening screws.

Screw quality

Swisspearl offers Facade Screws in A2. A2 is the standard offering for sub-urban or rural environments. Cleaning of screws should be done in order to avoid surface contamination.

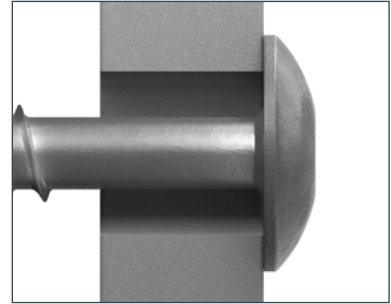

Fig. 1



Fig. 2

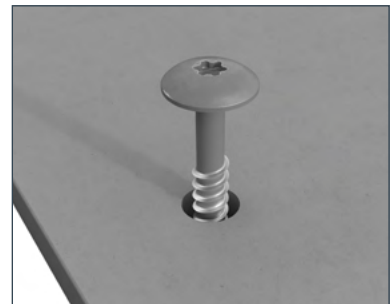

Fig. 3

Accessories

Rivets

Rivets for Swisspearl facade boards

Use Swisspearl Steel Rivets (Fig. 1)
RIV-S EPDM 4.8 x 20mm

Use Swisspearl Fixing Sleeves at the fixing positions - see page 18.

Installing Swisspearl facade boards using rivets

Before installing the boards, pre-drill holes in Swisspearl facade boards using a $\varnothing 9$ mm drill (Fig. 2).

Dust from cutting or drilling must be removed with a brush or compressed air immediately after the work has been completed, otherwise it can mark the surface of the boards.

Before drilling the holes in the steel profiles, place the facade board in its intended position on the steel structure. You can hold the board in place using locking pliers or use a supporting board below the facade board.

Centralising tool

Position the centralising tool (Fig. 3) through the pre-drilled hole in the board to ensure accurate fixing hole positions in the steel profiles that perfectly match the board's hole positions. Use an 4.9mm HSS Drill (Fig. 4) for drilling fixing positions in the steel.

Alternatively, a Centralizing Bit Drill (Fig. 5) can be used.

For the fixing points, you must insert the rivets into the Swisspearl Fixing Sleeves (Fig. 6) and install them at the fixing positions of the board.

All other rivets are installed without the fixing sleeve to allow the boards to move freely in the sliding points.

The Stand-Off Head (Fig. 7) must be used for all rivets. This provides a small space between the board and the rivet head to allow for movement caused by moisture or temperature changes.

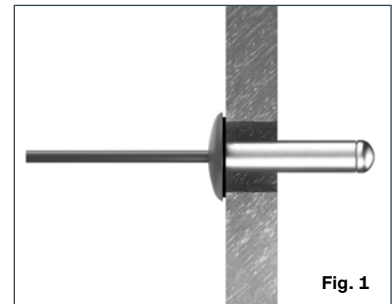

Fig. 1

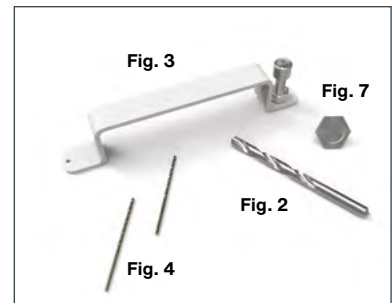

Fig. 3

Fig. 7

Fig. 2

Fig. 4

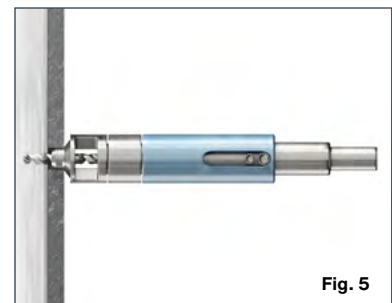

Fig. 5

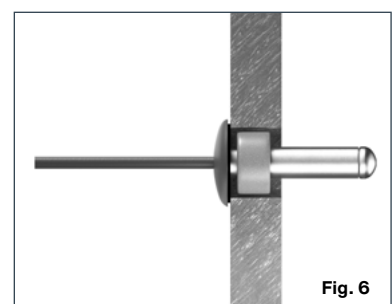

Fig. 6

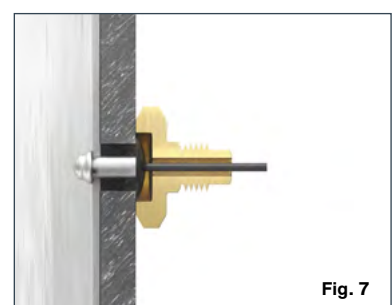

Fig. 7

Accessories

Swisspearl Blade

To ensure a neat finish when cutting Swisspearl facade boards, it is important to use the correct blade. Swisspearl recommends using Swisspearl Blades as they have been customised for the purpose and leave you with the best end-result.

The blades have trapezoidal diamond teeth which provide excellent cutting quality and extremely long durability. In addition, the amount of dust generated is significantly reduced compared to similar blades. The Swisspearl Blade is available in 4 sizes depending on which saw is used.

The Swisspearl blade can be used with dive saw, circular saw and stationary circular saw.

The Swisspearl Blade is a high quality product that can be sharpened, thus improving asset cost efficiency.

To achieve the best quality cut and to know which side to cut from, make sure to follow the instructions shown here. The direction varies depending on which saw you use.

Handling

When cutting the facade boards, do not force the sawblade through the board. If you force the saw, the blade might overheat causing small vibrations - affecting the straightness of the cut or causing the board to flake if near the edges. The blade depth must be adjusted so that the blade goes max 10mm through the board.

It is important to remove dust caused by cutting and drilling immediately either with a soft brush or a vacuum cleaner as it otherwise might damage the boards. Ensure that the boards are properly cleaned before installation, and if necessary use clean water, or water with a mild detergent and a soft sponge, or brush to remove dirt and dust from the surface.

Local requirements regarding safety must always be followed. Make sure to use correct safety equipment such as masks and dust ventilation and ensure that the saw is set up correctly according to the manufacturer's instructions. Never use water when cutting Swisspearl facade boards.

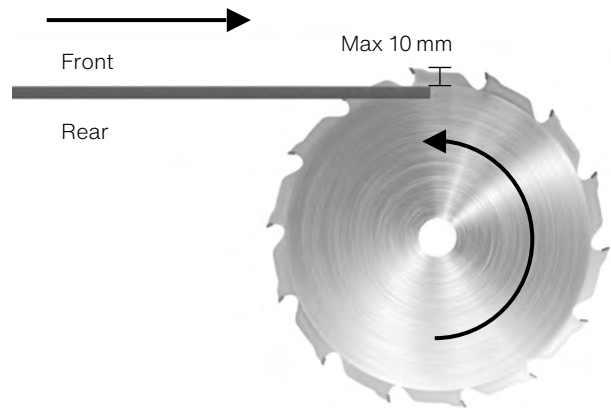

When using a table saw, place the board with the face uppermost on the table and cut from the rear of the board.

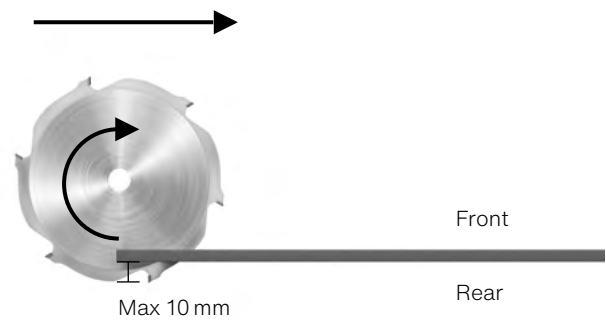

When using a mitre saw, cut the board from the front.

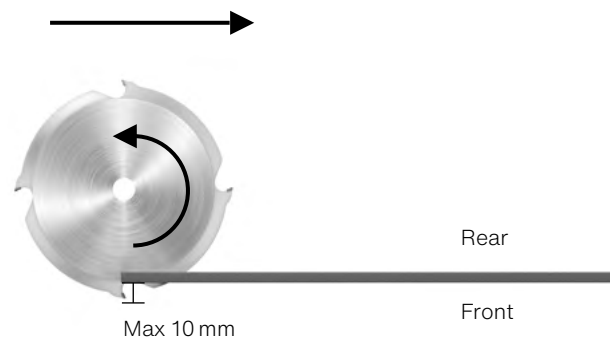

When using a circular saw or dive saw, cut the board from the rear.

Storing and Handling

Swisspearl products are delivered with plastic protection cover. If undamaged, the plastic cover provides good protection against dust and weather conditions during transportation.



Always store Swisspearl products on a flat dry level surface.



Only two pallets must be stacked on top of each other. Make sure they are positioned so they stand securely and stable.



If the pallets are stored outside when they arrive at the building site, the plastic cover should be removed. The facade boards should be stored on the pallet or sleepers with max 500mm distances.



Replace the plastic with a tarpaulin. It is very important that there is ventilation all around the tarpaulin and also on top of the pallet under the tarpaulin. This is done to make sure that condensation is reduced as much as possible.

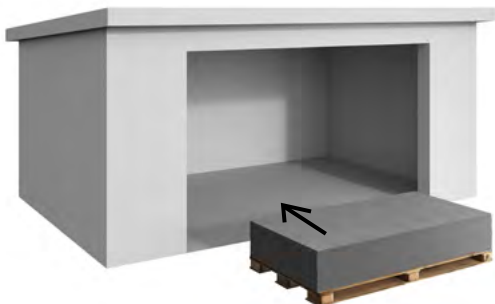

If Swisspearl facade boards are stored more than 2-3 weeks on site, the pallets should be kept under a roof to ensure dry and ventilated conditions.



Do not drag products from the pallet, as it may leave permanent scratch marks. Lift the product by its narrow edge as it may break if handled incorrectly.

Care & Maintenance

On-site

Cleaning of boards after cutting and drilling

It is important to immediately remove dust caused by cutting and drilling from the front and rear of the boards with a soft brush/duster or a vacuum cleaner, as it otherwise might damage the boards. Ensure that the boards are properly cleaned before installation, and if necessary use clean water or water with a mild detergent and a soft sponge or brush to remove dirt and dust from the surface. Thereafter, wipe the boards with a damp cloth. It may also be necessary to wash the surface after installation if the building site conditions have been unfavourable. This is done with lots of clean water or water with a mild detergent and a soft sponge or brush and finally wiping the boards with a damp cloth.

Removal of calcium-based residues

Calcium carbonate residue may occasionally be seen on the board surface. This can be difficult to remove with water or even with detergents because it does not dissolve in water. For cleaning purposes 10% acetic acid (CH₃COOH) solution is used to dissolve the calcium compounds.

Note! Carefully observe safety precautions (MSDS) when working with acetic acid. R-phrase R36/R38 is valid: "Irritating to eyes, respiratory system and skin". Use proper clothing, nitrile rubber gloves, eye protection goggles and approved respirator (filter A, E or A/E).

Carry out the mixing outdoors. Apply the diluted

10% acetic acid solution evenly with a spray can to the surface of the stained board. Leave it to react for a few minutes. Do not allow the solution to dry, but rinse with lots of clean water. Repeat the process if necessary and rinse with water afterwards.

Note! Do not execute the cleaning process with acetic acid in direct sunlight or on hot surfaces. This might create permanent stains.

Cleaning of neighbouring areas

Windows and glass in particular but also other adjacent areas must be kept clean during the facade board installation and if necessary protected with plastic film. Alkaline leaching from cement bonded materials (dust from cutting or drilling holes in structural concrete, etc.) is prone to damaging glass and other materials. Therefore, frequent cleaning during and after the construction period is needed.

Surface damages and scratches

Damages and scratches should be avoided by lifting the boards off the pallet and handling them carefully during installation. Scratches might leave white streaks on the surface which will turn dark when exposed to rain, because the board absorbs water through the scratch. Repair paint is not available. In any case the dark area will diminish after 6 to 12 months, because of the carbonation reactions in the cement matrix of the board.

Behaviour in wet conditions

Since the boards are made of Portland cement, their colour may turn darker when exposed to rain if the board absorbs moisture through holes, scratches or insufficiently sealed edges. This is natural behaviour for any cement-based product and it does not affect the integrity or long-term durability of the board. The original colour is restored as soon as the boards dry out. The darkening will show after heavy rainfall for the first months after installation. It will gradually reduce within 6 to 12 months, because the cement-based matrix reacts with carbon dioxide from the atmosphere – carbonation – and thereby reduces water penetration.

Care & Maintenance

After installation

Annual Inspection

Normally Swisspearl facade boards do not require any maintenance. Weathering may however influence the appearance of the facade. Therefore, an annual inspection of the ventilation gaps, joints and fixings is a good idea. Detection and repair of possible damage ensures a prolonged lifespan for the facade.

Cleaning

Swisspearl facade can be cleaned with cold or luke-warm water if necessary with the addition of a mild household cleaning agent not containing solvents. Always start from below with well-defined areas. Rinse with plenty of clean water until the facade is perfectly clean. Before cleaning full scale, it is recommended to test the chosen cleaning method on a smaller area to ensure it works and does not damage the board surface.

High-Pressure Cleaning

Warning! High Pressure Cleaning is a severe treatment for fibre cement facade. Exaggerated or wrong use of a high pressure cleaner may damage the surface. Therefore, High Pressure Cleaning is not recommended.

Moss & algae

Moss and algae growth can be removed with common agents available on the market. Care should be taken to ensure that the cleaning agent does not cause damage to the surface of the Swisspearl facade boards.

Confirm the compatibility of your cleaning agent with your cleaning agent supplier, and ensure it is applied according to the supplier's instructions. It is advised that before conducting a large-scale application a test is carried out on a small, inconspicuous area to ensure that the cleaning agent has no effect on the colour of Swisspearl facade boards.

Efflorescence

Efflorescence is a naturally occurring, white, powdery deposit that can appear on cement-based building materials (including bricks, cement walls, grout, and fibre cement). It is the result of a process in which moisture draws salt crystals to the surface, evaporates, and leaves a chalky substance behind. Efflorescence occurs when all three of the following conditions exist:

1. Water-soluble salts are present in the building material.
2. There is enough moisture in the wall to turn the salts into a soluble solution.
3. There is a path for the soluble salts to get to the surface.

Efflorescence may also be a sign of water ingress behind the facade. Make certain that all openings are properly covered and there is no water intrusion due to over-driven nails.

While some efflorescence may weather away naturally on its own, it is best to take steps to treat it. Efflorescence can be removed with household white vinegar and water. For most cases of efflorescence, Step 1 - 3 works well. But for substantial deposits of efflorescence go to Step 4. For best results, follow these cleaning instructions:

1. Protect areas that are not to be cleaned. Rinse all plants and vegetation around the facade with water before and after application of the vinegar.
2. Generously coat the entire surface area with vinegar. Allow the solution to sit on the surface for 10 minutes.
3. Rinse the treated area thoroughly with water from the top down and allow the area to air dry.
4. For extra tough efflorescence: Use a 10% acetic acid solution and apply to affected area with a cotton cloth. A light scrubbing with the cotton cloth may be required. After about 20 seconds rinse with water.

Health and Safety

As with all building materials, safety precautions must be taken into account and local laws and regulations must be observed.

Cutting and drilling

When cutting, grinding or drilling, dust from the fibre cement boards is released. This dust is characterised as mineral dust. Breathing large amounts of dust may cause irritation to respiratory functions, eyes or skin. Therefore, Swisspearl always recommends wearing personal protection equipment or stated by local law (Safety goggles, safety suit and a respiratory mask - P2 marked).

When cutting Swisspearl facade boards ensure adequate ventilation.

If the boards are cut indoors, it may be necessary to use an extractor system or a HEPA filter vacuum attachment attached to the power saw. When cutting outdoors, you should also use a HEPA filter vacuum attachment to the power saw. If ventilation is not adequate to limit exposure, wear a disposable respirator or air purifying cartridge respirator fitted with a Class P2 filter (European EN 143 standard). To reduce exposure to dust, Swisspearl recommends using Swisspearl Circular Blade.

Lifting Swisspearl facade boards

When lifting Swisspearl facade boards, please consider your lifting methods both in terms of safety but also to avoid damaging the boards. When lifting or moving the facade board, please make sure to lift the board by its narrow edge as it may otherwise break if handled incorrectly. If lifting Swisspearl facade board manually, make sure to adhere to any local rules. When lifting large boards, use mechanical lifting gear if possible. If this lifting gear uses suction/vacuum, be careful not to apply too much suction, as this may damage the surface or leave permanent marks.

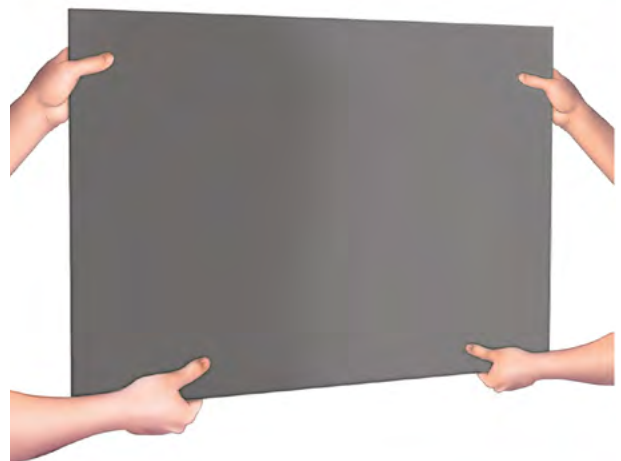
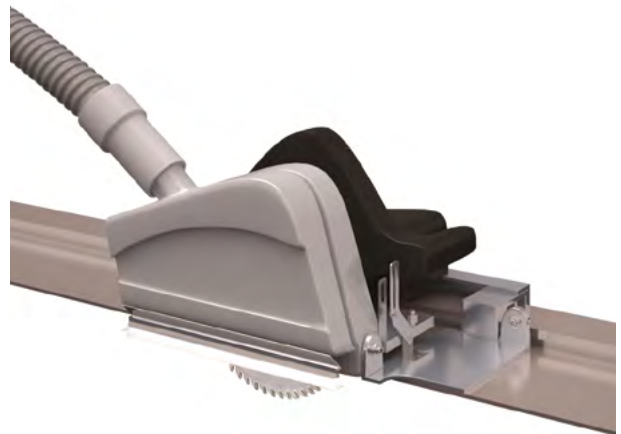
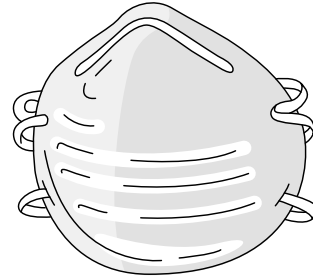

Onsite Handling

Swisspearl facade boards are supplied with a polyethylene foam layer between each board to prevent scratching and damage to the surface. The polyethylene is an environmentally friendly polymer that can be disposed of as normal combustible waste.



When marking the boards, make sure that marks are no larger than the hole to be drilled or no thicker than the blade that is to cut the board, as it can be difficult to remove marks from the board afterwards.



Once boards are cut, you can bevel the cut edge with a fine grinder (80 grain) to give the edge a pre-cut finish. The bevel should be angled at 45° relative to the board. This retains edge strength and removes small irregularities.



If not using Swisspearl Facade Wing Screws, the boards should be pre-drilled with an appropriate fibre cement drill bit. Dust from cutting or drilling must be removed with a brush or a fiber cloth immediately after the work has been completed, otherwise it can mark the surface of the boards.







Swisspearl Group AG

Eternitstrasse 3
8867 Niederurnen
Switzerland
P: +41 55 617 11 60
F: +41 55 617 12 71
info@swisspearl.com

swisspearl.com