

# DIM Design & Installation Manual

Swisspearl Plank Original





# Table of Contents

Product Information	2
Rear ventilated rainscreen claddings	3
Range	4
Accessories	6
Profile Use	8
Storing and Handling	10
Cutting and Sealing	11
Framing and Clearances	12
Fixing	13
Installation Methods	14
Care & Maintenance	18
Painting	19
Health & Safety	20
Warranty	21

# Product Information

## Eliminate maintenance and moisture problems

Swisspearl Plank is made of materials which consists of non-toxic, inorganic raw materials. This means that they remain unaffected by the presence of moisture during and after installation. Swisspearl Plank products are fibre cement based planks and panels with associated trims. Fibre cement is a modern building material made from natural and environmentally friendly raw materials. With more than 90 years of experience within the manufacturing of fibre cement, Swisspearl ensures a sustainable product that has accumulated all the advantages of fibre cement.

## Quality

All products are CE marked and manufactured to meet or exceed the specifications outlined in the EN 12467:2012+A1:2016 Fibre-cement flat sheets, Category A2.

Swisspearl fibre cement planks are vapour permeable products which are resilient to the toughest weather conditions experienced around the world. The products consist of grey cement and cellulose filler reinforced with a specially selected fibres. Fibre cement absorbs and releases moisture without affecting the durability, strength or performance of the product. All products resist both rot and fungal growth and can withstand considerable fluctuations in weather and climate conditions. Adding to this, Swisspearl Plank is non-combustible and offers a fire protection of A2-s1,d0 when installed with joints between boards to a maximum of 3mm, meaning they will never contribute to fire.

## Paints

Swisspearl Plank comes with a painted surface. An automated painting process seals each piece for maximum resistance to exterior exposure which is backed by a Swisspearl 15 year warranty. We offer a broad spectrum of pre-finished design possibilities and special colours are available upon request.

Farbcode	Farbbezeichnung
CP 010	Agate Grey
CP 030	Pebble Grey
CP 040	Granite Grey
CP 050	Bark Brown
CP 080	Basalt Grey
CP 150	Anthracite Grey
CP 180	Signal Black
CP 210	Pure White
CP 280	Silk Grey
CP 370	Oxide Red
CP 380	Red Brown
CP 410	Light Brown
CP 480	Dark Brown

For RAL / NCS colours, go to [www.Swisspearl.com](http://www.Swisspearl.com)  
Please note that 100% colour matching is not possible, paint must be toned locally.

## Notes

0 = Grey  
1 = Black  
2 = White  
3 = Red  
4 = Brown

Colour Gloss: Flat 5 - 10

# Rear ventilated rainscreen claddings

The self-ventilating facade is a physical construction which contributes to reducing temperature variations in the wall throughout the year. Sunlight is reflected in the summertime, and the dry insulation reduces heat loss in cold seasons. At the same time the construction ventilates interior condensation.

The cavity is ventilated by vent gaps at the bottom and top letting moisture evaporate naturally.

If the facade system is not ventilated, it does not allow any moisture to evaporate; which might lead to mould, fungi, etc. on systems without rear ventilation.

Cladding with Swisspearl products must always be carried out as a ventilated facade with min 25mm distance between the cladding and the sheathing or blockwork. However, in special situations (e.g. high rise buildings), local regulations may demand a larger ventilation gap. Inlet and outlet openings must have a cross section of least  $100\text{cm}^2/\text{m}$ .

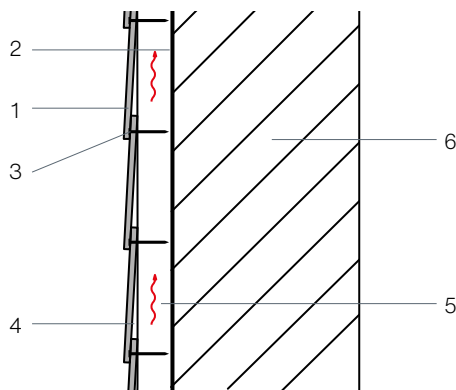

- 1 Swisspearl Plank 8mm
- 2 Sheathing or weatherproof membrane if specified
- 3 Fixing
- 4 Batten min 25mm
- 5 Ventilated area
- 6 Main structure

It must be ensured that there is free passage for ventilation at the bottom and top of a structure as well as ventilation under and over windows/doors etc.

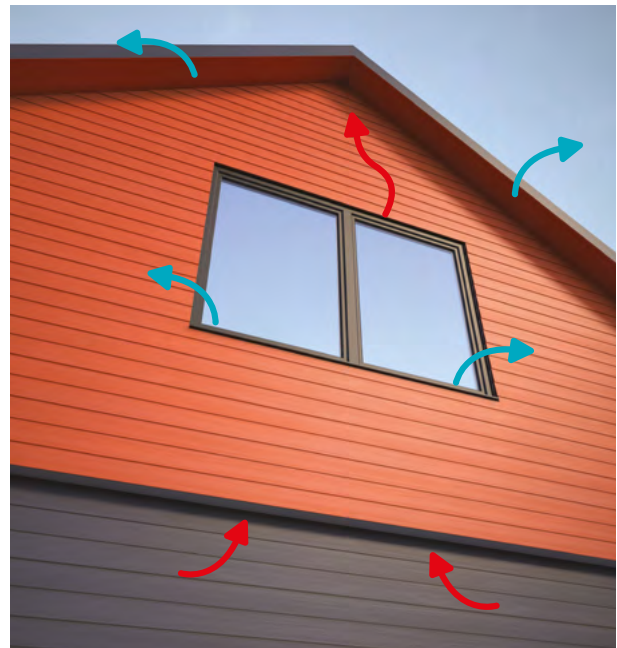

This passage must be a minimum of 15mm in the top and bottom or equal  $150\text{mm per m}^2$ . If grids or similar are used, the openings must equal  $150\text{cm}^2$  per linear meter.

Swisspearl offers several profiles that make it easy to create elegant solutions in the bottom and top of the cladding as well as around doors and windows.

# Range

## Swisspearl Plank



### Properties

---

Length	3600mm
Width	180mm
Thickness	8mm
Weight pcs	7.65kg
Surface	Textured
Coverage per square metre (Including overlap)	1.85 pcs
fixings per square metre (Framing fixing centres 600mm)	12.8 pcs



# Accessories

**For a quick overview of profile use,  
see the next pages**

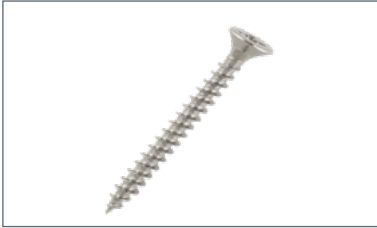

**Swisspearl 30 Stainless Steel Wood Screw**

4.0 x 30mm A2 stainless steel - For hidden fixing on timber battens



**Swisspearl 27 Steel Screw**

3.9x27mm Zytex GX – For hidden fixing on steel battens. Also available for auto feed screwdrivers



**Swisspearl Facade Wood Screws**

4.5x41mm A2 – For visible fastening on timber battens. Available in all colours



**Swisspearl Facade Steel Screws**

4.8x35mm A2 – For visible fastening on steel battens

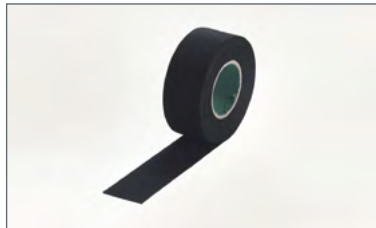

**Swisspearl EPDM 45/95mm**

To protect battens from water



**Swisspearl Plank Acrylic Paint 0.5L**

100% Acrylic Latex paint available in all colours



**Swisspearl Mechanical Shear**

Dust free cutting of fibre cement up to 30cm long and 8mm thick

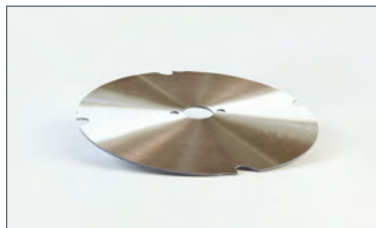

**Swisspearl Plank Circular Blade**

Fibre cement blade for circular saw  
Ø160x2.2x20mm  
Ø190x2.2x30mm



**Swisspearl Gecko Gauge**

Acting as a second set of hands to measure and support the next plank for fastening

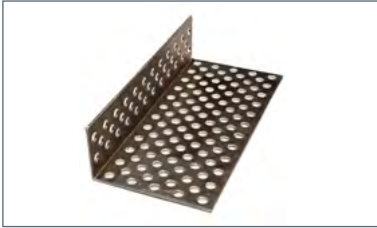

**1. Swisspearl Ventilated Profile**  
25x50mm aluminium start/end profile for panels and planks

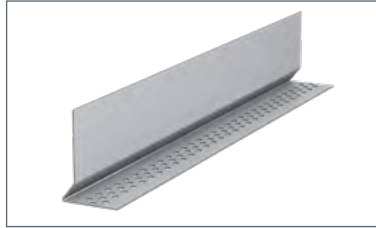

**2. Swisspearl Plank/Start Ventilation Profile**  
33x50mm aluminium start profile for planks (including 8mm kick out)

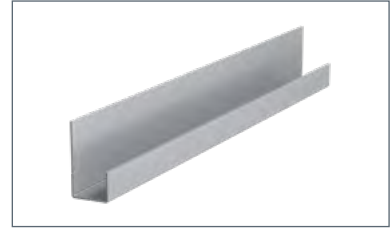

**3. Swisspearl End Profile**  
19x40mm coloured aluminium profile for vertical finishing

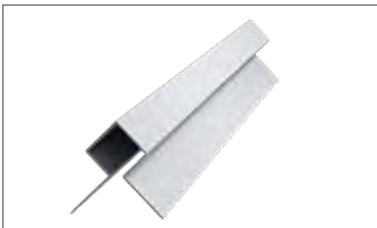

**4. Swisspearl External Corner Large**  
32x20x26mm coloured aluminium profile for 90° angle



**5. Swisspearl Internal Corner Profile**  
36x23x23mm coloured aluminium profile for 90° angle



**6. Swisspearl Window Sill Profile**  
25x130mm coloured aluminium external sill profile for horizontal finishing



**7. Swisspearl Vertical Trim Large**  
40x21x79mm coloured aluminium trim around doors and windows

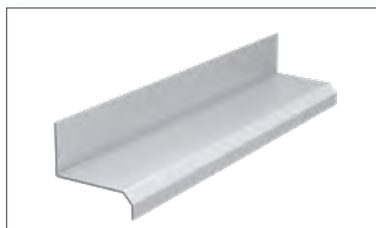

**8. Swisspearl Horizontal Trim Large**  
30x42x8x8mm coloured aluminium trim around doors and windows

# Profile Use



### 1. Swisspearl Ventilation Profile

To keep a well-ventilated area behind Swisspearl products, use a ventilation profile for allowing air to pass from bottom to top of the cladding, whilst preventing insects, vermin and the build up of debris.



### 2. Swisspearl Plank/Start Ventilation Profile

To maintain the correct distance outwards, the first plank should be 15mm below the profile. The bottom plank is mounted a minimum of 150mm from the terrain, and 50mm from roofing, balconies and other horizontal structures. We recommend painting the rear of the bottom plank, if distance is less than 150mm from terrain.



### 3. Swisspearl End Profile

The finish is easily obtained by using a Swisspearl End Profile. There must be a minimum of 5mm clearance from the plank to the profile, allowing proper water drainage.



### 4. Swisspearl External Corner Large

The finish is easily obtained by using a Swisspearl External Corner profile. There must be a minimum of 5mm clearance with an option of sealing between the plank and the profile.

# Profile Use



## 5. Swisspearl Internal Corner Profile

The finish is easily obtained by using a Swisspearl Internal Corner Profile. There must be a minimum of 5mm clearance with an option of sealing between the plank and the profile.

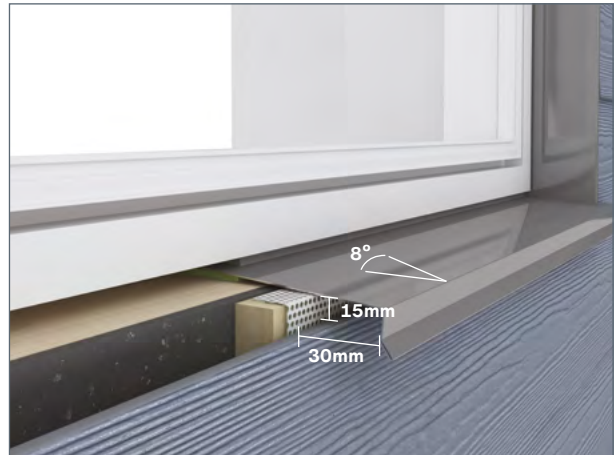

## 6. Swisspearl Window Sill Profile

Using a Swisspearl alu profile below windows is a long lasting and durable solution. Do not install Swisspearl Plank horizontally in areas where they will be subjected to water for longer periods. For proper ventilation, keep a minimum of 15mm distance to plank installed below.

For window sills longer than 3 metres, cut a slit in the underlying profile and overlap by 25mm. If used with a Swisspearl Vertical Trim profile, cut a slit in the Swisspearl window ledge profile and bend upwards to form a 25mm overlap.



## 7. Swisspearl Vertical Trim Large

The finish around windows and doors is easily obtained by using a Swisspearl Vertical Trim profile. There must be a minimum of 5mm clearance with an option of sealing between the plank and the profile.



## 8. Swisspearl Horizontal Trim Large

The finish above windows and doors is easily obtained by using a Swisspearl Horizontal Trim profile. There must be a minimum of 15mm clearance from the planks and framing structure to horizontal profiles, allowing proper water drainage. If used with a sheathing board the joint between the trim and the sheathing board must be sealed with exterior grade sealant. We recommend using a high quality, exterior-grade sealant.

# Storing and Handling



Store the pallets on a dry and level surface.



A maximum of 4 plank pallets can be stored on top of each other.

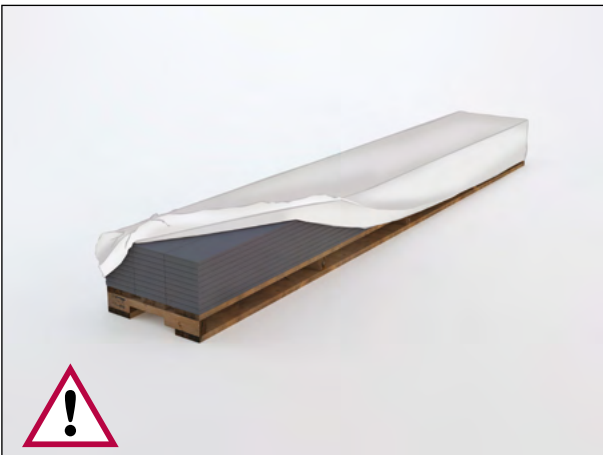

The original packaging may have sustained damage from transportation. Remove the plastic packaging immediately upon delivery at the building site, to avoid risk of efflorescence.

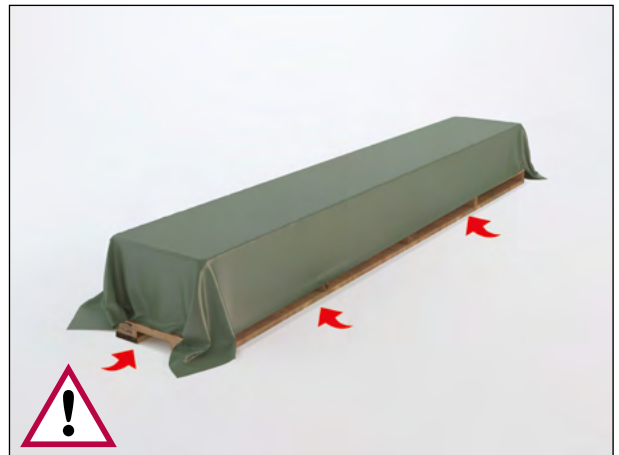

Important: Store materials under a dry and well-ventilated tarpaulin. If the product becomes damp, it should be placed on its vertical edge to allow rapid drying. Never install wet products.



If storing on site for more than 2-3 weeks, the product should be kept under a roof. A maximum of 4 plank pallets can be stored on top of each other.

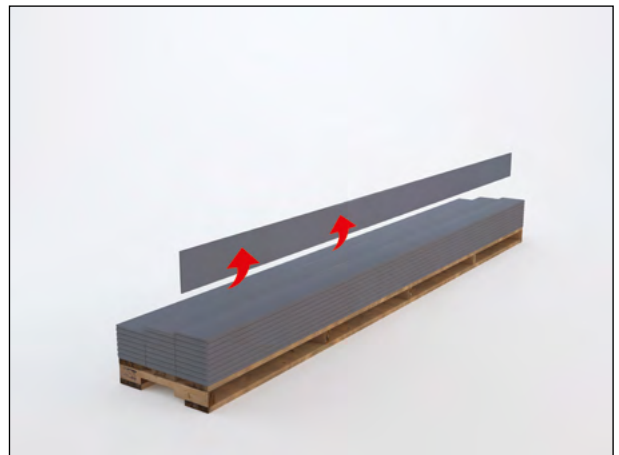

Do not drag products from the pallet, as it may leave permanent scratch marks. Lift the product by its narrow edge as it may break if handled incorrectly.

# Cutting and Sealing

When fibre cement is cut, dust is created. This dust may contain crystalline silica which can pose a health risk. To ensure adequate ventilation, always work outdoors and use cutting tools that minimise dust. Or use a HEPA filter vacuum attachment for power saws equipped with a Swisspearl Plank Circular Blade to reduce exposure to below applicable exposure limits. Never use water when cutting.

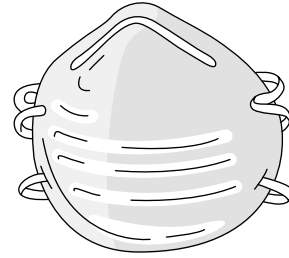

If ventilation is not adequate to limit exposure, wear a disposable respirator or air purifying cartridge respirator fitted with a Class P2 filter (European EN 143 standard). Cut the product by using a polycrystalline diamond-tipped blade. To reduce exposure to dust we recommend using Swisspearl Plank Circular Blade. For a non-ventilated and dust free environment, we recommend using Swisspearl Mechanical Shear.

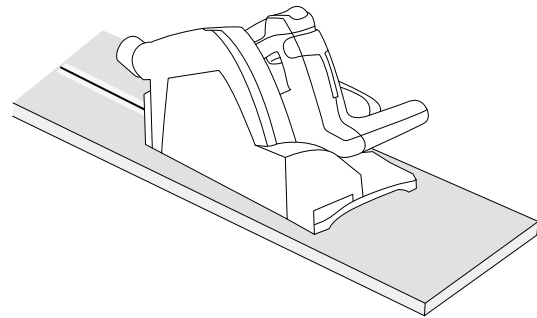

When making cut-outs use a Jigsaw with a carbide blade for fibre cement. As an alternative for small tasks, use a rough woodcutting blade.

To keep edges from chipping, first test the saw on an off-cut to assess whether the plank is best cut face or rear up. Take care to remove dust from the surface after installation, as leftover cement particles will leave permanent marks if left sitting in the sun.

All on-site cuts (planks, panels, trim) must be resealed with 100% acrylic latex paint before installing. We recommend using Swisspearl Plank Acrylic Paint.

Be sure to apply sealant wherever the weatherboarding meets the trim and around all windows and doors. We recommend using a high quality, exterior-grade sealant.

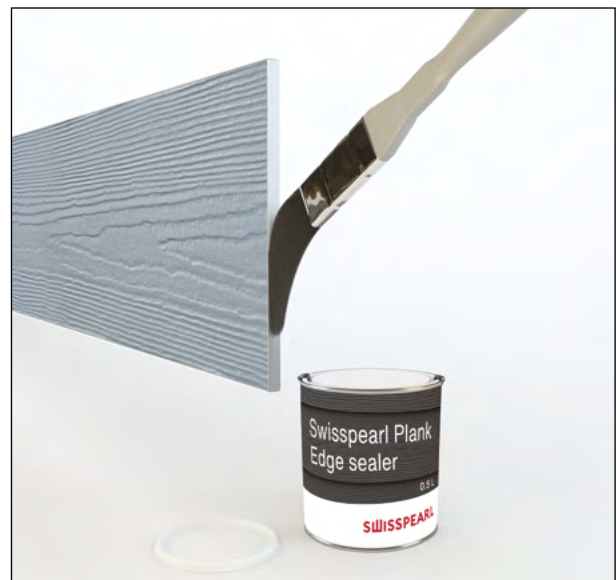

# Framing and Clearances

Swisspearl recommends installing Swisspearl Plank on a straight frame - any inconsistencies in the straightness will be noticeable on the finished surface. The rear of the planks and top of the wall should always be protected from rain/water ingress to prevent efflorescence.

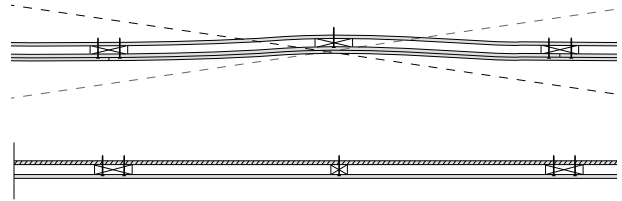

There must be a minimum of 150mm from the terrain to the bottom of the Swisspearl Plank. The clearance from balconies and other horizontal areas must be a minimum of 50mm from structures to the bottom of the products. Do not install product directly in contact with water or surfaces that collect water.

Swisspearl Plank can be installed together with a Swisspearl Windstopper.

It is important to allow air to flow freely behind the facade product. Keep a minimum distance of 25mm behind the product and a minimum of 10mm gap at the top and bottom of the weatherboarding.

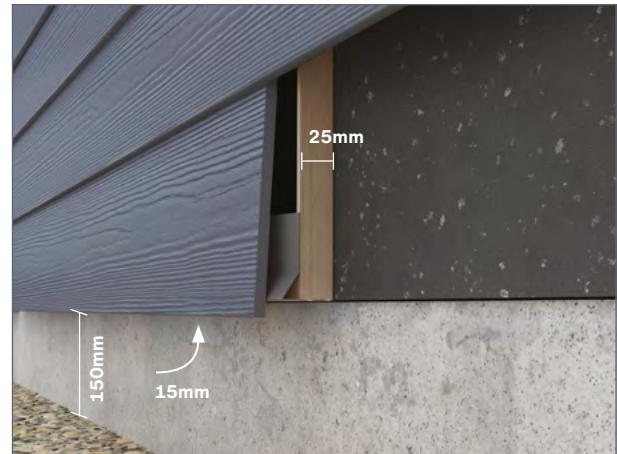

There must be a minimum of 5mm (vertical) and 15mm (horizontal) clearance around windows/doors-/framing/metal trim and other building materials to allow for structural movements and proper water drainage and ventilation.



If using untreated timber battens, we recommend using Swisspearl EPDM 45/95mm to keep water out.

## Installation options

1. Fix a  $\approx 200$ mm Swisspearl EPDM 45/95mm strip on the batten centered above the butt joint, let it extend 20mm on the plank below.

2. Mount Swisspearl EPDM 45/95mm on the batten in full length. Use Swisspearl EPDM 45 for middle battens and Swisspearl EPDM 95 at butt joint battens.

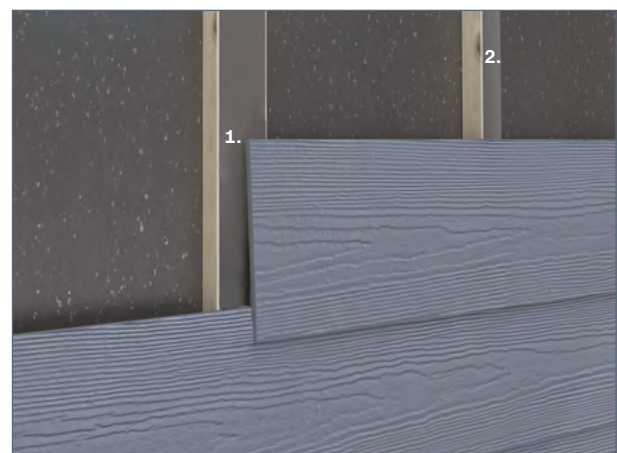

# Fixing

Timber battens				Steel	
				0.56 – 2.0mm Steel	0.7 – 1.25mm Steel
Swisspearl facade wood screw	Swisspearl 30 wood screw	Nailing by hand	Nail gun	Swisspearl facade steel screws	Swisspearl 27 steel screw
4.5x41mm stainless steel A2 – For visible fastening	4.0x30mm hardened steel – For hidden fixing	2.5x55mm Ring Nail galvanized steel – For hidden fixing	2.5x50mm Coil Nail galvanized steel – For hidden fixing	4.8x35mm stainless steel A2 – For visible fastening	3.9x27mm hardened steel ZYTEC GX – For hidden fixing

## On wood

It may be necessary to pre-drill the holes at the corners to prevent the edges from breaking. Nails must penetrate a minimum of 30mm into the structural framing.

If using screws, a minimum of 20mm must penetrate the structural framing.

If using non-Swisspearl recommended screws, please be aware whether the screws require more than 20mm penetration to resist lateral loads.

All nails or screws must be corrosion resistant stainless steel, or double dipped galvanized.

## On steel

For hidden fixing on steel, we recommend using Swisspearl 27 Steel Screw.

When using metal battens, Swisspearl screws must penetrate into the metal framing a minimum of 7mm.

## Distances

1. For hidden fixing, all fasteners must be a minimum of 25mm from top edges.

2. For visible fixing no closer than 20mm from other edges and planks corners.

Fixings must never be closer than 16mm to wood batten edges.

**TIP!** When using visible nail fasteners on Swisspearl Planks, please refrain from using 2 nails on top of each other (inner and outer board), as the outer nail will work its way outwards over time.

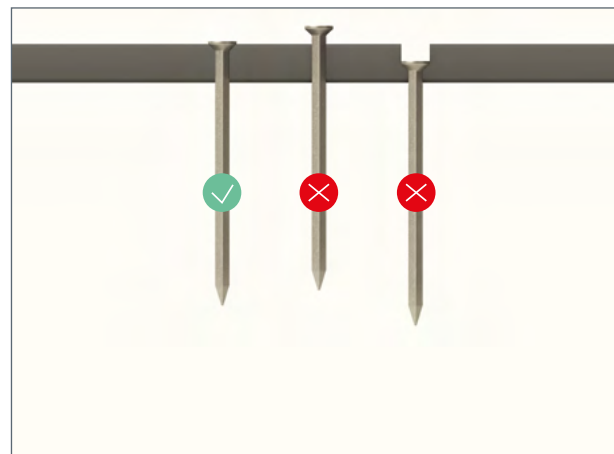

Do not countersink or angle fixings. Surely fixings must not be proud the surface of the plank.

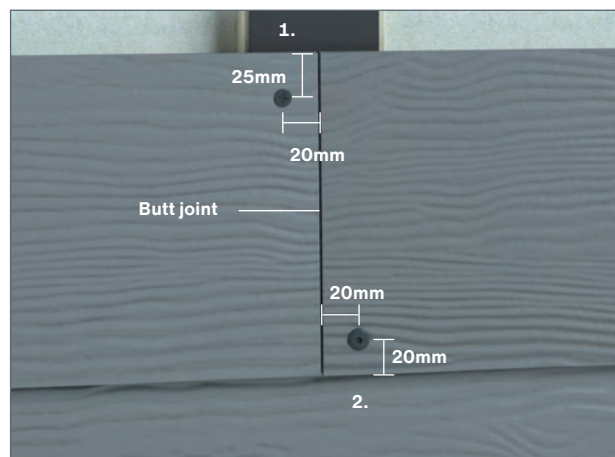

When butt jointing, make sure planks are loosely butt jointed.

# Installation Methods

## Swisspearl Plank horizontal

Swisspearl Plank installation on wood or steel

1. Swisspearl Windstopper or similar
2. Wood or Swisspearl Ventilated Wall Profile 70/100
3. Swisspearl Plank

Batten min. thickness: A distance of 25mm is needed for ventilation.

Minimum width: For middle battens 45mm

Minimum width: For butt joint battens 75mm

Maximum distance between battens fixing centres 600mm

Always install Swisspearl Plank from the bottom of the wall. Starting 1 cm below Swisspearl Plank/Start Ventilation Profile.

Use 30mm overlapping of each 180mm plank, by setting a mark for every 150mm upwards.

When butt jointing, make sure planks are loosely butt jointed and always over a batten to avoid warping.

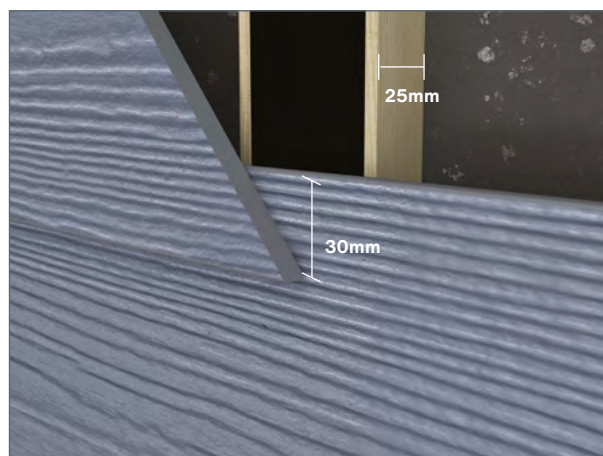
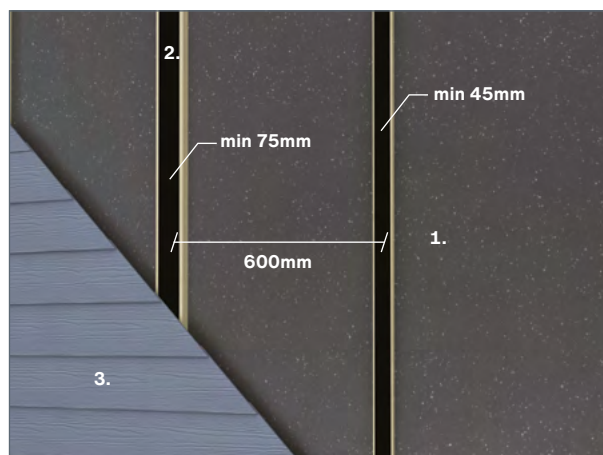

For fast, easy and accurate installation, we recommend using a Swisspearl Gecko Gauge. The Geckos assist in creating the correct overlap and ensure proper location of the screw or nail. Using a Gecko Gauge set clamped to either end of the Planks, makes it possible for one man to install Swisspearl Planks.

**NB!** The Geckos do not scratch or leave marks on the painted planks.

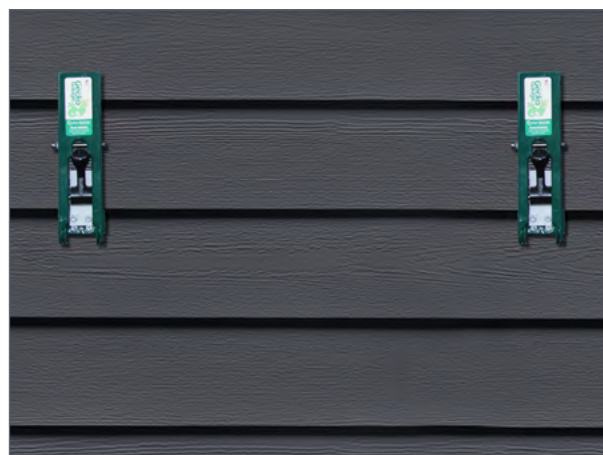

# Installation Methods

## Swisspearl Plank on ventilated wood framing

1. Swisspearl Windstopper or similar
2. Vertical batten min 25mm thickness, max o.c 1000mm.
3. Horizontal batten 38x56mm.
4. Swisspearl Plank

Maximum distance between horizontal battens o.c 600mm.

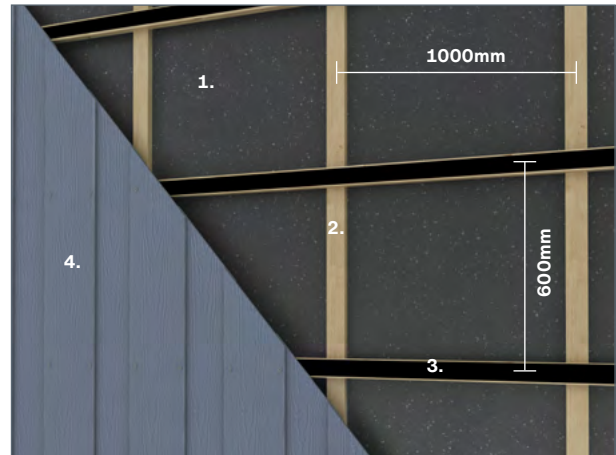

## Fixing for visible fastening on steel or wood frame

The Upper plank overlaps the edge of the plank by at least 20mm on each edge. The underlying plank is fastened with nails or screws and the top plank with Swisspearl Facade Wood Screws 4.5x41mm on wood battens and Swisspearl Facade Steel Screws 4.8x35mm on steel profiles. The fastener is placed a minimum of 20mm from the edge and 20mm from the top and bottom corner.

### Distance for the planks

Inner plank fixing centres 300mm distance  
Outer plank fixing centres 300mm distance

To avoid efflorescence as a result of water ingress, it is recommended painting 50mm of the rear of the plank along each overlapping edge.

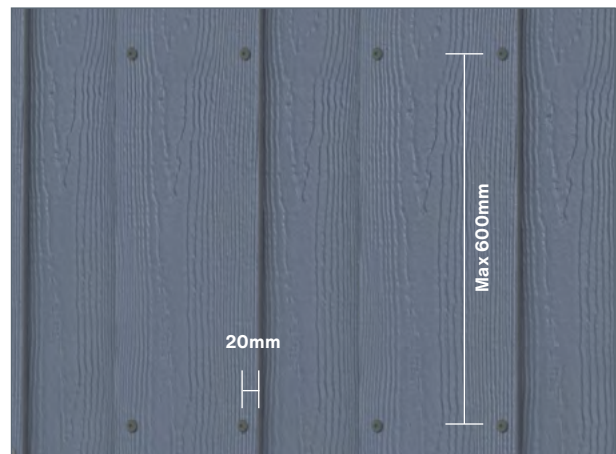

For visible fastening on timber battens, we recommend using Swisspearl Facade Screw.

# Installation Methods

## Swisspearl Plank used as roof trim or dormer

Swisspearl Plank can be used as roof trim or dormer. Maximum width of Swisspearl Plank without ventilation is 400mm.



## Swisspearl Panel used as soffit

Swisspearl Panel can also be used as soffit when cut to the correct size. Always make sure there is proper ventilation. Maximum distance between battens fixing centres 400mm.

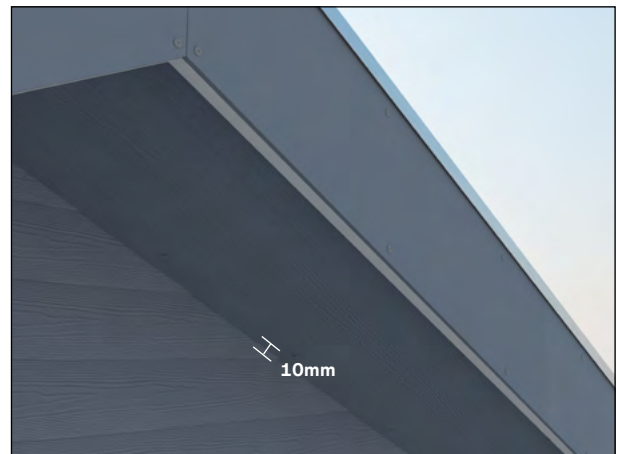

## Swisspearl Panel used on dormer

Swisspearl Panel may also be applied on dormer and other large surfaces where the use of planks can be difficult. Swisspearl Panel can be installed either in large format or cut in to size.

**NB!** For more information about the fastening and sub constructions, see page 14. If applying the Swisspearl Plank and Swisspearl Panel on soffits or dormers, remember to leave a gap of min 10mm along the edge for a well-ventilated construction. All on-site cuts must be resealed with 100% acrylic latex paint before installing.





# Care & Maintenance

## Annual Inspection

Normally a Swisspearl facade cladding does not require any maintenance to keep up its strength, properties and function. Weathering impacts may however influence the visual appearance of the facade. Therefore, an annual inspection of the ventilation gaps, joints and fixings is a good idea.

Detection and repair of possible damage secures a prolonged lifetime for the facade.

## Cleaning

Swisspearl claddings can be cleaned with cold or lukewarm water if necessary with the addition of a mild household cleaning agent not containing solvents. Always start from below with well-defined areas.

Rinse with plenty of clean water until the facade is perfectly clean.

Before cleaning full scale, it is recommended to test the chosen cleaning method on a smaller area to make sure it answers its purpose.

## High Pressure Cleaning

Warning! High Pressure Cleaning is a severe treatment for fibre cement cladding. Exaggerated or wrong use of a high pressure cleaner may damage the surface. Therefore, High Pressure Cleaning is not recommended.

## Moss & algae

Moss and algae growth can be removed with common agents available on the market. Examples are hypochlorite (e.g. trademark: Klorin) that has no long-term effect or benzalconiumchloride (e.g. trademark: Rodalon) 2.5% active that has a long term effect preventing new growth.

After wetting the facade with clean water, the agent is applied according to the supplier's instructions. Do not leave the agent to dry completely. Rinse with lots of clean water.

## Efflorescence

Efflorescence is a naturally occurring, white, powdery deposit that can appear on cement-based building materials (including bricks, cement walls, grout, and fibre cement). It is the result of a process in which moisture draws salt crystals to the surface, evaporates, and leaves a chalky substance behind. Efflorescence occurs when all three of the following conditions exist:

1. Water-soluble salts are present in the building material.
2. There is enough moisture in the wall to turn the salts into a soluble solution.
3. There is a path for the soluble salts to get to the surface

Efflorescence may also be a sign of water intrusion behind the weatherboarding. Make certain that all openings are properly covered and there is no water intrusion due to over-driven nails.

While some efflorescence may weather away naturally on its own, it is best to take steps to treat it. Efflorescence can be removed with household white vinegar and water. For most cases of efflorescence, Step 1 - 3 works well. But for substantial deposits of efflorescence go to Step 4.

For best results, follow these cleaning instructions: Protect areas that are not to be cleaned. Rinse all plants and vegetation around the facade with water before and after application of the vinegar

Generously coat the entire surface area with vinegar. Allow the solution to sit on the surface for 10 minutes. Rinse the treated area thoroughly with water from the top down and allow the area to air dry.

For extra tough efflorescence:

Use a 10% acetic acid solution (E.g. 1 part Vinegar Acid 32% and 2 parts Water) and apply to affected area with a cotton cloth. A light scrubbing with the cotton cloth may be required. After about 20 seconds rinse with water.

# Painting

All Swisspearl Planks, Panels & Trim are factory sealed. Reseal cut edges with a high-quality 100% acrylic latex paint before installation.

Use only top quality, exterior type, acrylic latex paints. Confirm the compatibility of your paint to fibre cement with your paint supplier. Swisspearl recommends a 100% acrylic latex paint using only the highest-grade paints.

Use a high-quality 100% acrylic latex paint. Before applying the finish coat, always follow the paint manufacturer's recommendation for surface preparation and paint application.

**NOTE:** Never apply oil-based paints to Swisspearl Planks, Panels or Trim. Always paint out of direct sunlight and with a 100% clean and dry surface, above 10° Celsius. Take care to paint entire planks before stopping, as drying lines will show.

**Swisspearl is not responsible for surface paints and workmanship.**

# Health and Safety

## **Avoid breathing silica dust**

As for all other building materials, adherence to local building rules and regulations when working with Swisspearl products is required. Working with crystalline silica containing products should be conducted in well-ventilated conditions by use of simple and effective precautions.

When cutting, grinding or drilling, respirable crystalline silica is released. Breathing large amounts of dust may cause irritation to respiratory functions, eyes and/or skin.

Therefore wear personal protection equipment (Safety goggles, safety suit and a respiratory mask - P2 marked) See safety data sheet for full and final information.

Ensure adequate ventilation at workstation. For best practice use Swisspearl Mechanical Shear.

Remove dust after installation with water to suppress airborne dust particles.

# Warranty

## **Warranty**

Warranty conditions can be commissioned at your local Swisspearl representative.

## **Disclaimer**

The information contained in this publication and otherwise supplied to users of Swisspearl products is based on Swisspearl's general experience, best knowledge and belief. However, due to factors which fall beyond Swisspearl's knowledge and control, which can affect the use of the products, no warranty is given expressed or implied with respect to fitness for particular purpose or otherwise.

Swisspearl's policy is one of continuous improvement. Swisspearl therefore reserves the right to alter specifications at any time and without notice. Colours and textures may vary according to light and weather conditions. Owing to this and limitations of the printing process, colours in this brochure may vary.

Please, ensure that you have the latest version of this publication by checking that the publication date corresponds with the downloadable version from our website. In case of doubt, please contact your local Swisspearl representative.



**Swisspearl GB Ltd.**

Unit 1a, Birchwood One Business Park  
Birchwood, Warrington  
Cheshire WA3 7GB, United Kingdom  
+44 (0) 203 372 2300  
info@gb.swisspearl.com

**swisspearl.com**